



Certified Minority Business Enterprise



the **Power** to  
Create Better  
Light <sup>TM</sup>



# LED RETROFIT LIGHTING SOLUTIONS

[www.espentech.com](http://www.espentech.com)

A night cityscape featuring several tall skyscrapers with illuminated windows. In the foreground, a highway shows light trails from moving vehicles. A large, semi-transparent circular graphic with a glowing blue border is centered over the image. The text "THE POWER TO CREATE BETTER LIGHT" is written in white, sans-serif capital letters within this circle. The word "LIGHT" is significantly larger and bolder than the other words.

THE POWER  
TO CREATE  
BETTER **LIGHT**



ESPEN Technology is dedicated to delivering sustainable and environmentally progressive lighting solutions. As a manufacturer and designer of high efficiency lighting products, ESPEN continually strives to improve the efficiency of lighting technology. Our products reflect an emphasis on sustainability, quality, and reliability. Our product development is driven by a simple commitment: to improve people's lives and build a better future for generations to come.

Our ESPEN products are complemented by an industry-leading warranty policy. The goal is to offer our customers and end-users an invaluable asset: peace of mind. With an emphasis on quality and a focus on efficiency, ESPEN Technology's engineers have developed a whole line of LED drivers, lamps, modules, retrofit kits, emergency solutions and control systems that are worthy of the latest LED luminaires. High efficiency, advanced thermal management, increased life, and versatility in form create the ultimate LED systems for today's most advanced LED lighting. Stringent component qualification and quality control guarantee a long life and increased overall system longevity.



Not all products are qualified on the DLC QPL. To view our DLC qualified products, please consult the DLC Qualified Products List at [www.designights.org/qpl](http://www.designights.org/qpl)



# TABLE OF CONTENTS

Type A, B and A+B Series

## RetroFlex™



### TYPE A, PLUG & PLAY, BALLAST COMPATIBLE LED LAMPS

- 1..... Introduction
- 2..... T5 Linear Glass & Plastic Lamps
- 3..... T8 Linear Nano Plastic Lamps
- 4..... T8 Linear Glass Lamps
- 5..... T8 Slimline Lamps
- 6..... Compact Lamps
- 7..... Drivers and Ballasts for Type A Lamps
- 8..... **Emergency Ballasts for Type A Lamps**

## Flex™



### TYPE B LED LAMPS

- 9..... Introduction
- 10..... T5 Lamps
- 11..... 5CCT T8 Lamps
- 12..... T8 & T5 Nano Plastic Lamps
- 13..... T8 0-10V Dimming Lamps
- 14..... T8 Linear Glass Lamps
- 15..... T8 Slimline Lamps
- 16..... T8 HO Lamps
- 17..... PLL Lamps
- 18..... Compact Lamps
- 19..... 360° Sign Lamps
- 20-21.... **Emergency Inverters for Type B Lamps**

## UniFlex™



### TYPE A + B LED LAMPS

- 22..... Introduction
- 23..... T8 Linear Lamps
- 24..... T8 Slimline & HO Lamps
- 25..... U bent Lamps
- 26..... **Emergency Ballast and Inverter for Type A + B Lamps**

# TABLE OF CONTENTS

Type-C Series, Retrofit & Emergency Solutions



## TYPE C LED LAMPS WITH EXTERNAL DRIVE

- 27-28..... Introduction
- 29-32..... T5 & T8 Linear Lamps, Nano Plastic
- 33-34..... LED Drivers for Type C Lamps
- 35..... **Emergency Inverter for Type C Lamps**

## VersaKIT™



## LED RETROFIT KITS

- 36..... Introduction
- 37..... Commercial Recessed Downlight
- 38..... **Emergency Inverter**
- 39-43..... Linear Module Retrofit Kits
- 44..... Panel Retrofit Kit
- 45..... Troffer Retrofit Kit
- 46..... Channel Retrofit Kit
- 47..... LED Strip Retrofit Kit

## SENTINEL®



## EMERGENCY SOLUTIONS

- 48..... Introduction
- 49..... Standalone Emergency Back Up Kits
- 50..... Type-B Emergency Inverters
- 51..... Type-A Emergency Ballasts

## CONTROLS



## CONTROLS

- 52..... Step-Down Transformers
- 53..... High Bay Sensors
- 54..... 0-10V Dimmers
- 55-56..... Bi Level Daylight Harvest Sensor
- 57-58..... versaDim RF Wireless Control System
- 59..... versaDim RF Adapter
- 60-62..... versaDim RF Lamp

# RetroFlex™

Plug & Play | Ballast Compatible LED Lamps | Type A

TYPE - A



## linearLED

Med, Bi-Pin, Single-Pin, Double-Recess Pin  
Long Life, Convenient Wiring



## RetroFlex led driver

Dedicated Driver, Instant Start  
Constant Current, 0-10V Dimming



## emergency ballast

Maintenance-Free, Long Life  
Hi-Temperature Ni-Cad Battery

# RetroFlex™

LED Solutions  
Plug and Play



**ARMORCOAT™**  
SHATTER-RESISTANT COATED LAMPS

Safety Coated, Shatter-Resistant Lamps



## ballast replacement

High Efficiency, Slim Profile, Instant Start,  
Program Start

## ABOUT ESPEN RETROFLEX LED LAMPS

ESPEN Retroflex LED lamps lead the industry with ballast compatible, plug & play technology. These high-performance lamps don't require any alteration to the fixture. The upgrade to LED technology is as simple as replacing the old fluorescent lamps with new Retroflex lamps. This saves you up to 50% of system power while maintaining or increasing illumination levels. These lamps work directly off your existing electronic ballasts, within your fixtures, and come in a range of shapes and sizes.

\*Please visit [www.espentech.com](http://www.espentech.com) for compatibility list.

# RetroFlex™

Plug & Play | Ballast Compatible LED T5 Lamps



## FEATURES AND BENEFITS

- LED Replacement for T5 Fluorescent Lamps
- Works with fluorescent electronic ballast (**Programmed Start, Dimming**)
- Quick and Convenient Installation
- Utilizes Existing Shunted or Non-Shunted Tombstones
- Instant on, No delay
- Convenient and quick installation
- Frosted to Prevent Glare
- Suitable for Damp Locations
- Integrated Thermal Fuse Protection
- ETL Sanitation Listed - *conforms to NSF/ANSI 2*
- Maintains the original UL Certification of the Fixture
- Compatible with Controls and Sensors
- Rated for Use in Food Prep Areas and Refrigerated Food Displays
- -20° F to 130° F Ambient Operating Temp
- 5 Year Warranty
- 240° Wide Beam Angle
- Dimmable



TYPE - A

Model No.	Replaces	Length (in)	Lamp Power (W)	System Power (W)	Lumens (lm)	Lamp Efficacy (lm/W)	Input Voltage (V)	CCT (K)	CRI	Life (h)
<b>Linear T5 High Efficiency (HE) Plastic</b>										
L48T5HE/850/13P-EB	F28T5HE	48	13	16	1600	123	120 - 277	3000	83+	50000
L48T5HE/850/13P-EB	F28T5HE	48	13	16	1600	123	120 - 277	3500	83+	50000
L48T5HE/850/13P-EB	F28T5HE	48	13	16	1600	123	120 - 277	4000	83+	50000
L48T5HE/850/13P-EB	F28T5HE	48	13	16	1600	123	120 - 277	5000	83+	50000
<b>Linear T5 High Output (HO) Plastic</b>										
L24T5/830/12P-EB	F24T5HO	24	12	15	1500	125	120 - 277	3000	83+	50000
L24T5/835/12P-EB	F24T5HO	24	12	15	1500	125	120 - 277	3500	83+	50000
L24T5/840/12P-EB	F24T5HO	24	12	15	1500	125	120 - 277	4000	83+	50000
L24T5/850/12P-EB	F24T5HO	24	12	15	1500	125	120 - 277	5000	83+	50000
L36T5/830/18P-EB	F39T5HO	36	18	21	2000	111	120 - 277	3000	83+	50000
L36T5/835/18P-EB	F39T5HO	36	18	21	2000	111	120 - 277	3500	83+	50000
L36T5/840/18P-EB	F39T5HO	36	18	21	2000	111	120 - 277	4000	83+	50000
L36T5/850/18P-EB	F39T5HO	36	18	21	2000	111	120 - 277	5000	83+	50000
L48T5/830/24P-EB	F54T5HO	48	24	27	3300	137	120 - 277	3000	83+	50000
L48T5/835/24P-EB	F54T5HO	48	24	27	3300	137	120 - 277	3500	83+	50000
L48T5/840/24P-EB	F54T5HO	48	24	27	3300	137	120 - 277	4000	83+	50000
L48T5/850/24P-EB	F54T5HO	48	24	27	3300	137	120 - 277	5000	83+	50000
<b>Linear T5 High Output (HO) Glass</b>										
L48T5HO/830/24G-EB	F54T5HO	48	24	27	3200	133	120 - 277	3000	83+	50000
L48T5HO/835/24G-EB	F54T5HO	48	24	27	3200	133	120 - 277	3500	83+	50000
L48T5HO/840/24G-EB	F54T5HO	48	24	27	3200	133	120 - 277	4000	83+	50000
L48T5HO/850/24G-EB	F54T5HO	48	24	27	3200	133	120 - 277	5000	83+	50000

# RetroFlex™



Plug & Play | Ballast Compatible LED T8 Lamps: Shatterproof

TYPE - A



## FEATURES AND BENEFITS

- LED Replacement for T8 Fluorescent Lamps
- Shatterproof Nano Plastic Tube
- Works with fluorescent electronic ballast (**Instant Start, Programmed Start, Dimming**)<sup>1</sup>
- Quick and Convenient Installation
- Utilizes Existing Shunted or Non-Shunted Tombstones
- Instant on, No delay
- Convenient and quick installation
- Suitable for Damp Locations
- Integrated Thermal Fuse Protection
- ETL Sanitation Listed -conforms to NSF/ANSI 2
- Maintains the original UL Certification of the Fixture
- Compatible with Controls and Sensors
- Rated for Use in Food Prep Areas and Refrigerated Food Displays
- -20° F to 130° F Ambient Operating Temp
- 5 Year Warranty
- 325° Wide Beam Angle



Model No.	Replaces	Length (in)	Lamp Power (W)	System Power (W)	Lumens (lm)	Lamp Efficacy (lm/W)	Input Voltage (V)	CCT (K)	CRI	Life (h)
<b>Linear T8</b>										
L24T8/830/12P-EB	F32T8	24	9	11	1500	167	120 - 277	3000	83+	50000
L24T8/835/12P-EB	F32T8	24	9	11	1500	167	120 - 277	3500	83+	50000
L24T8/840/12P-EB	F32T8	24	9	11	1500	167	120 - 277	4000	83+	50000
L24T8/850/12P-EB	F32T8	24	9	11	1500	167	120 - 277	5000	83+	50000
L36T8/830/12P-EB	F32T8	36	12	14	1750	146	120 - 277	3000	83+	50000
L36T8/835/12P-EB	F32T8	36	12	14	1750	146	120 - 277	3500	83+	50000
L36T8/840/12P-EB	F32T8	36	12	14	1750	146	120 - 277	4000	83+	50000
L36T8/850/12P-EB	F32T8	36	12	14	1750	146	120 - 277	5000	83+	50000
L48T8/830/10P-EB	F32T8	48	10	12	1750	175	120 - 277	3000	83+	50000
L48T8/835/10P-EB	F32T8	48	10	12	1750	175	120 - 277	3500	83+	50000
L48T8/840/10P-EB	F32T8	48	10	12	1750	175	120 - 277	4000	83+	50000
L48T8/850/10P-EB	F32T8	48	10	12	1750	175	120 - 277	5000	83+	50000
L48T8/830/12P-EB	F32T8	48	12	14	1850	154	120 - 277	3000	83+	50000
L48T8/835/12P-EB	F32T8	48	12	14	1850	154	120 - 277	3500	83+	50000
L48T8/840/12P-EB	F32T8	48	12	14	1850	154	120 - 277	4000	83+	50000
L48T8/850/12P-EB	F32T8	48	12	14	1850	154	120 - 277	5000	83+	50000
L48T8/830/14P-EB	F32T8	48	14	16	2150	154	120 - 277	3000	83+	50000
L48T8/835/14P-EB	F32T8	48	14	16	2150	154	120 - 277	3500	83+	50000
L48T8/840/14P-EB	F32T8	48	14	16	2150	154	120 - 277	4000	83+	50000
L48T8/850/14P-EB	F32T8	48	14	16	2150	154	120 - 277	5000	83+	50000

<sup>1</sup> System Power and Lumens based on normal ballast factor (0.88). Operation on low and high ballast factor will yield alternate specification.  
<sup>2</sup> Voltage is dependant on ballast brand and model number. See espentech.com for ballast compatibility list.

# RetroFlex™

Glass Plug & Play | Ballast Compatible | LED T8 Lamps



## FEATURES AND BENEFITS

- No rewiring needed
- Works with fluorescent electronic ballast (**Instant Start, Programmed Start, Dimming**)<sup>1</sup>
- Long life / High CRI
- -20° F to 130° F Ambient Operating Temp
- Instant on, no delay
- Convenient and quick installation
- Utilizes existing instant start or rapid start sockets
- No Mercury, No UV
- Compatible with controls and sensors
- Works in cold temperature applications
- Glass tube for superior optical performance
- 325° Wide View Angle
- Dimmable
- 5 Year Warranty



TYPE - A

Model No.	Replaces	Length (in)	Lamp Power (W)	System Power (W)	Lumens (lm)	Lamp Efficacy (lm/W)	Input Voltage (V)	CCT (K)	CRI	Life (h)
L24T8/8XX/8G-EB	F17T8 <sup>1</sup>	24	8	10 <sup>2</sup>	1100	110	120 - 277	3000-5000K	83+	50000
L36T8/8XX/10G-EB	F25T8 <sup>1</sup>	36	10	13 <sup>2</sup>	1600	160	120 - 277	3000-5000K	83+	50000
<b>Above Products: 8XX Equals 3000K, 3500K, 4000K, or 5000K Transitioned to UniFlex Type A + B Solutions. See Page 23</b>										
L48T8/830/10G-EB	F32T8 <sup>1</sup>	48	10	13 <sup>2</sup>	1950	195	120 - 277	3000	83+	50000
L48T8/835/10G-EB	F32T8 <sup>1</sup>	48	10	13 <sup>2</sup>	1950	195	120 - 277	3500	83+	50000
L48T8/840/10G-EB	F32T8 <sup>1</sup>	48	10	13 <sup>2</sup>	1950	195	120 - 277	4000	83+	50000
L48T8/850/10G-EB	F32T8 <sup>1</sup>	48	10	13 <sup>2</sup>	1950	195	120 - 277	5000	83+	50000
L48T8/830/12G-EB	F32T8 <sup>1</sup>	48	12	14 <sup>2</sup>	1800	150	120 - 277	3000	83+	50000
L48T8/835/12G-EB	F32T8 <sup>1</sup>	48	12	14 <sup>2</sup>	1800	150	120 - 277	3500	83+	50000
L48T8/840/12G-EB	F32T8 <sup>1</sup>	48	12	14 <sup>2</sup>	1800	150	120 - 277	4000	83+	50000
L48T8/850/12G-EB	F32T8 <sup>1</sup>	48	12	14 <sup>2</sup>	1800	150	120 - 277	5000	83+	50000
L48T8/830/14G-EB	F32T8 <sup>1</sup>	48	14	16 <sup>2</sup>	2100	150	120 - 277	3000	83+	50000
L48T8/835/14G-EB	F32T8 <sup>1</sup>	48	14	16 <sup>2</sup>	2100	150	120 - 277	3500	83+	50000
L48T8/840/14G-EB	F32T8 <sup>1</sup>	48	14	16 <sup>2</sup>	2100	150	120 - 277	4000	83+	50000
L48T8/850/14G-EB	F32T8 <sup>1</sup>	48	14	16 <sup>2</sup>	2100	150	120 - 277	5000	83+	50000

<sup>1</sup> See espentech.com for ballast compatibility list.  
<sup>2</sup> System Power and Lumens based on normal ballast factor (0.88). Operation on low or high ballast factor will yield alternate specifications.

# RetroFlex™

Plug & Play | Ballast Compatible LED T8 Lamps | Slimline

TYPE - A



Anti-Rotation Bracket



## FEATURES AND BENEFITS

- LED Replacement for T8 & T12 Fluorescent Lamps
- **ArmorCoat™** Shatterproof Coating
- **Works with fluorescent electronic ballast (Instant Start, Programmed Start, Dimming)**<sup>1</sup>
- Quick and Convenient Installation
- Utilizes Existing Shunted or Non-Shunted Tombstones
- Instant on, No delay
- Convenient and quick installation
- Frosted to Prevent Glare
- Suitable for Damp Locations
- Integrated Thermal Fuse Protection
- Maintains the original UL Certification of the Fixture
- Compatible with Controls and Sensors
- Rated for Use in Food Prep Areas and Refrigerated Food Displays
- 5 Year Warranty
- 325° Wide Beam Angle
- Dimmable
- -20° F to 130° F Ambient Operating Temp
- Glass Tube for Optimal Light Output and Heat Diffusion
- **96" Lamps ONLY Compatible with ESPEN VE259MVHIP Ballasts**

Model No.	Replaces	Base Type	Length (in)	Lamp Power (W)	System Power (W)	Lumens (lm)	Lamp Efficacy (lm/W)	Input Voltage (V)	CCT (K)	CRI	Life (h)
<b>Single Pin Linear T8</b>											
L96T8/830/24G-EB	F96T8, F96T12	FA8	96	24	27 <sup>1</sup>	3500	146	120 - 277, 347	3000	83+	50000
L96T8/835/24G-EB	F96T8, F96T12	FA8	96	24	27 <sup>1</sup>	3500	146	120 - 277, 347	3500	83+	50000
L96T8/840/24G-EB	F96T8, F96T12	FA8	96	24	27 <sup>1</sup>	3500	146	120 - 277, 347	4000	83+	50000
L96T8/850/24G-EB	F96T8, F96T12	FA8	96	24	27 <sup>1</sup>	3500	146	120 - 277, 347	5000	83+	50000

**Transitioned to UniFlex Type A + B Solutions. See Page 24**

<sup>1</sup> System Power and Lumens based on normal ballast factor (0.88). Operation on low or high ballast factor will yield alternate specifications.



# RetroFlex™

Plug & Play | Ballast Compatible | Compact LED Bulbs



## FEATURES AND BENEFITS

- Comply with UL 1993/UL18750
- Comply with FCC 47 PART 15 CLASS B
- Works with electronic ballast (instant start, rapid start and program start)
- No UV, No Mercury
- Dimmable with Espen Type A LED Driver
- Quick Installation
- High Lumen
- Extended Life
- High Quality Color Rendering
- 5 Year Limited Warranty



Model No.	Replaces	Base Type	Length	Lamp Power (W)	System Power (W)	Lumens (lm)	Lamp Efficacy (lm/W)	Input Voltage (V)	CCT (K)	CRI	Life (h)
<b>CLQ Compact lamps</b>											
CLQ18WH/827-EB	26W	G24q	6.65	9	12	900	100	120 - 277	2700	82	50000
CLQ18WH/830-EB	26W	G24q	6.65	9	12	900	100	120 - 277	3000	82	50000
CLQ18WH/835-EB	26W	G24q	6.65	9	12	900	100	120 - 277	3500	82	50000
CLQ18WH/840-EB	26W	G24q	6.65	9	12	900	100	120 - 277	4000	82	50000
CLQ18WH/850-EB	26W	G24q	6.65	9	12	900	100	120 - 277	5000	82	50000
CLQ18WV/827-EB	26W	G24q	4.68	9	12	900	100	120 - 277	2700	82	50000
CLQ18WV/830-EB	26W	G24q	4.68	9	12	900	100	120 - 277	3000	82	50000
CLQ18WV/835-EB	26W	G24q	4.68	9	12	900	100	120 - 277	3500	82	50000
CLQ18WV/840-EB	26W	G24q	4.68	9	12	900	100	120 - 277	3000	82	50000
CLQ18WV/850-EB	26W	G24q	4.68	9	12	900	100	120 - 277	3500	82	50000

TYPE - A



## FEATURES AND BENEFITS

- Comply with UL 1993/UL1598
- Comply with FCC 47 PART 15 CLASS B
- 18W/26W G24d magnetic ballast compatible
- No UV, No Mercury
- Quick Installation
- High Lumen
- Extended Life
- High Quality Color Rendering
- 5 Year Limited Warranty



Model No.	Replaces	Base Type	Length	Lamp Power (W)	System Power (W)	Lumens (lm)	Lamp Efficacy (lm/W)	Input Voltage (V)	CCT (K)	CRI	Life (h)
<b>CLD Compact lamps</b>											
CLD18WH/827-MB	26W	G24d	6.65	9	12	900	100	120 - 277	2700	82	50000
CLD18WH/830-MB	26W	G24d	6.65	9	12	900	100	120 - 277	3000	82	50000
CLD18WH/835-MB	26W	G24d	6.65	9	12	900	100	120 - 277	3500	82	50000
CLD18WH/840-MB	26W	G24d	6.65	9	12	900	100	120 - 277	4000	82	50000
CLD18WH/850-MB	26W	G24d	6.65	9	12	900	100	120 - 277	5000	82	50000
CLD18WV/827-MB	26W	G24d	4.68	9	12	900	100	120 - 277	2700	82	50000
CLD18WV/830-MB	26W	G24d	4.68	9	12	900	100	120 - 277	3000	82	50000
CLD18WV/835-MB	26W	G24d	4.68	9	12	900	100	120 - 277	3500	82	50000
CLD18WV/840-MB	26W	G24d	4.68	9	12	900	100	120 - 277	3000	82	50000
CLD18WV/850-MB	26W	G24d	4.68	9	12	900	100	120 - 277	3500	82	50000

# RetroFlex™

## LED Drivers & Ballasts for Type A Lamps

TYPE - A

### NON-DIMMABLE DRIVERS FEATURES AND BENEFITS

- Constant Current
- Universal Voltage (120-277V)
- Energy Efficient Design
- Micro Case: Same mounting for T8 and T12 ballasts
- High Performance
- 5 Year Limited Warranty
- Model No.: VEL50BN-2C (2 LAMP)  
VEL100BN-4C (4 LAMP)



### DIMMABLE DRIVERS FEATURES AND BENEFITS

- Constant Current
- 0-10V Continuous Dimming: 10%-100%
- Universal Voltage (120-277V)
- Slim Profile
- 5 Year Limited Warranty
- Model No.: VEL30BN-2C-10V (2 LAMP)  
VEL60BN-4C-10V (4 LAMP)



### ELECTRONIC BALLASTS FEATURES AND BENEFITS

- Full Ballast Line
- Slim Profile
- Lamp Auto Restrike
- High Efficiency
- Commercial Ballasts Backed by 5 Year Limited Warranty



Model No.	Type	Lamps	Voltage	Method
VE2P32MVHIPE	F17T8-F32T8	1 or 2	120-277V	Instant Start
VE259MVHIP	F96T8	2	120-277V	Instant Start
VE254MVHRP	F54T5HO	2	120-277V	Program Start
VE454MVHRP	F54T5HO	4	120-277V	Program Start

SUGGESTED BALLAST REPLACEMENTS FOR RETROFLEX LED LAMPS.  
FOR MORE BALLAST OPTIONS PLEASE CHECK ESPEN WEBSITE WWW.ESPENTECH.COM

# RetroFlex™

## Type A Emergency Ballasts for T5 and T8 Lamps

### FEATURES AND BENEFITS

TYPE - A



500 Lumens

#### VEM500DV-L - Emergency Ballast

- Dual Input Voltage (120/277V)
- Maintenance Free, Long Life
- High Temperature Ni-Cad Battery
- Durable, Heavy-Duty Steel Housing
- 1-lamp: 500 lumens
- 5 Year Limited Warranty



800 Lumens

#### VEM800DV-L - Emergency Ballast

- Dual Input Voltage (120/277V)
- Maintenance Free, Long Life
- High Temperature Ni-Cad Battery
- Durable, Heavy-Duty Steel Housing
- 1-lamp: 800 lumens
- Slim Design
- 5 Year Limited Warranty



1300 Lumens

#### VEM1300DV-L - Emergency Ballast

- Dual Input Voltage (120/277V)
- Maintenance Free, Long Life
- High Temperature Ni-Cad Battery
- Durable, Heavy-Duty Steel Housing
- 1-lamp: 1,300 lumens | 2-lamp: 1,300 lumens
- Slim Design
- 5 Year Limited Warranty



Model No.	Type	Lumens	Voltage (V)	Operation Hours	Case
VEM500DV-L	Emergency Ballast	500	120/277	90 mins	Regular
VEM800DV-L	Emergency Ballast	800	120/277	90 mins	Slim
VEM1300DV-L	Emergency Ballast	1300	120/277	90 mins	Slim

\* Operating hours, 90min at full lumen output.  
 \*\* EM ballast will continue to produce light after 90min, but lumen output will reduce over time.

## LED LAMPS WITH INTERNAL DRIVER | Type B



### Compact LED

Internal Driver, Convenient Installation, Instant on with no delay or warm up time, High CRI, 5 year warranty



### Linear LED

Med. Bi-pin, Internal Driver, DLC Listed, Glass tube for superior optical performance, Utilizes unshunted (rapid start) sockets, Long Life, Available in 0-10V dimming, and 5-CCT.

### 360° Sign Lamps LED

Double-sided design, Rotatable endcaps, Compatible with sensors, Utilizes R17d sockets, Input from both ends



**Flex™**  
LED Solutions  
with Internal Driver

### Emergency Inverter

90 Minute Illumination Time



TYPE - B



### LED FT Lamps LED

Utilizes current 2G11 sockets, Internal Driver, Compatible with controls and sensors, Instant On



### Espen Flex LED Lamps

Espen Flex LED lamps have an internal driver that frees linear luminaires from old fluorescent ballasts and lamps. The lamp works directly off line input voltage 120/277V. Flex lamps make convenient and effective retrofit solutions for any old T12 system, especially with magnetic ballasts. Simply remove the old fluorescent ballast and wire line voltage directly to one side of the unshunted lamp holder. Flex lamps can save you up to 50% of system power, while maintaining or increasing illumination levels. Flex lamps come in a range of sizes including linear 2ft, 3ft, 4ft, 5ft, 6ft, and 8ft. The lamps are also available as 360° sign lamps for two-sided signs.

## AC Direct | T5 Lamps | Double Ended Input



### FEATURES AND BENEFITS

- Double Ended Bypass Connection
- Internal Driver
- Glass Tube for Optimal Light Output and Heat Dissipation
- -20° F to 130° F Ambient Operating Temperature
- Frosted to Prevent Glare
- Suitable for Damp Locations
- 240° Wide Beam Angle
- 5 Year Warranty



### WIRING DIAGRAM

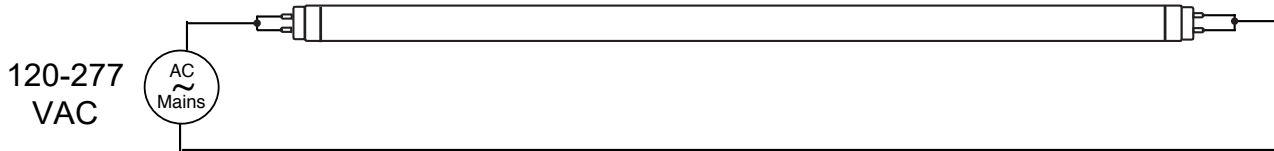

Model No.	Replaces	Length (in)	Lamp Power (W)	Lumens (lm)	Lamp Efficacy (lm/W)	Input Voltage (V)	CCT (K)	CRI	Life (h)
Linear T5 High Efficiency (HE)									
L48T5HE/830/12G-ID DE	F28T5HE	48	12	1800	150	120-277	3000	80+	50000
L48T5HE/835/12G-ID DE	F28T5HE	48	12	1800	150	120-277	3500	80+	50000
L48T5HE/840/12G-ID DE	F28T5HE	48	12	1800	150	120-277	4000	80+	50000
L48T5HE/850/12G-ID DE	F28T5HE	48	12	1800	150	120-277	5000	80+	50000

Model No.	Replaces	Length (in)	Lamp Power (W)	Lumens (lm)	Lamp Efficacy (lm/W)	Input Voltage (V)	CCT (K)	CRI	Life (h)
Linear T5 High Output (HO)									
L24T5/830/7G-ID DE	F24T5HO	24	7	900	128	120-277	3000	80+	50000
L24T5/835/7G-ID DE	F24T5HO	24	7	900	128	120-277	3500	80+	50000
L24T5/840/7G-ID DE	F24T5HO	24	7	900	128	120-277	4000	80+	50000
L24T5/850/7G-ID DE	F24T5HO	24	7	900	128	120-277	5000	80+	50000
L36T5/830/12G-ID DE	F39T5HO	36	12	1700	141	120-277	3000	80+	50000
L36T5/835/12G-ID DE	F39T5HO	36	12	1700	141	120-277	3500	80+	50000
L36T5/840/12G-ID DE	F39T5HO	36	12	1700	141	120-277	4000	80+	50000
L36T5/850/12G-ID DE	F39T5HO	36	12	1700	141	120-277	5000	80+	50000
L48T5/830/25G-ID DE	F54T5HO	48	25	3500	140	120-277	3000	80+	50000
L48T5/835/25G-ID DE	F54T5HO	48	25	3500	140	120-277	3500	80+	50000
L48T5/840/25G-ID DE	F54T5HO	48	25	3500	140	120-277	4000	80+	50000
L48T5/850/25G-ID DE	F54T5HO	48	25	3500	140	120-277	5000	80+	50000

TYPE - B

## AC Direct | 5CCT T8 Lamp | Double Ended Input



### FEATURES AND BENEFITS

- Internal Driver
- Smooth, Consistent Light
- UL for Safety
- Long Life
- High CRI
- Convenient and quick installation
- Utilizes shunted or unshunted G13 sockets
- 5-CCT Field-Adjustable: 27K/30K/35K/40K/50K
- Works in cold temperature applications
- Suitable for damp and dry locations
- Glass tube for superior optical performance
- -4° F to 113° F ambient operating temperture
- 5 Year Warranty



### WIRING DIAGRAM

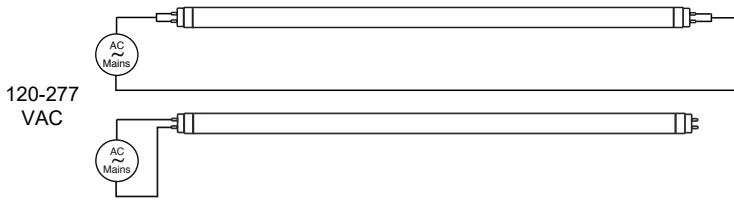

YES  
Shunted  
Instant Start Socket



YES  
Unshunted  
Rapid Start Socket

TYPE - B

Model No.	Length (in)	Base Type	Lamp Wattage	Input Voltage (V)	CCT (K)	Initial Lumens	CRI	Beam Angle	LPW	Power Factor	THD	Life (h)
<b>Linear T8</b>												
L48T8/8F/12G-ID DE	48	G13	12	120-277	2700	1600	82	200	133	.9	<20%	50000
	48	G13	12	120-277	3000	1600	82	200	133	.9	<20%	50000
	48	G13	12	120-277	3500	1650	82	200	138	.9	<20%	50000
	48	G13	12	120-277	4000	1800	82	200	150	.9	<20%	50000
	48	G13	12	120-277	5000	1600	82	200	150	.9	<20%	50000

## AC Direct | Nano Plastic Lamp | Double Ended Input



### FEATURES AND BENEFITS

- Double Ended Bypass Connection with Shunted or Non-Shunted Tombstones
- Internal Driver
- Compatible with Sensors
- Shatterproof Nano Plastic Tube
- Frosted to Prevent Glare
- -20° F to 130° F ambient operating temperature
- Suitable for damp locations
- 325° Wide Beam Angle
- 5 Year Warranty

### WIRING DIAGRAM

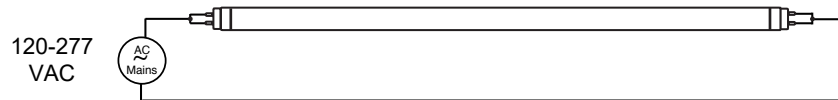

Model No.	Replaces	Length (in)	Lamp Power (W)	Lumens (lm)	Efficacy (lm/W)	Input Voltage (V)	CCT (K)	CRI	Life (h)
<b>Linear T8</b>									
L24T8/830/9P-ID DE	F17T8	24	9	1100	122	120 - 277	3000	83+	50000
L24T8/835/9P-ID DE	F17T8	24	9	1100	122	120 - 277	3500	83+	50000
L24T8/840/9P-ID DE	F17T8	24	9	1100	122	120 - 277	4000	83+	50000
L24T8/850/9P-ID DE	F17T8	24	9	1100	122	120 - 277	5000	83+	50000
L36T8/830/12P-ID DE	F25T8	36	12	1400	117	120 - 277	3000	83+	50000
L36T8/835/12P-ID DE	F25T8	36	12	1400	117	120 - 277	3500	83+	50000
L36T8/840/12P-ID DE	F25T8	36	12	1400	117	120 - 277	4000	83+	50000
L36T8/850/12P-ID DE	F25T8	36	12	1400	117	120 - 277	5000	83+	50000
L48T8/830/12P-ID DE	F32T8	48	12	1800	150	120 - 277	3000	83+	50000
L48T8/835/12P-ID DE	F32T8	48	12	1800	150	120 - 277	3500	83+	50000
L48T8/840/12P-ID DE	F32T8	48	12	1800	150	120 - 277	4000	83+	50000
L48T8/850/12P-ID DE	F32T8	48	12	1800	150	120 - 277	5000	83+	50000
L48T8/830/15P-ID DE	F32T8	48	15	2200	146	120 - 277	3000	83+	50000
L48T8/835/15P-ID DE	F32T8	48	15	2200	146	120 - 277	3500	83+	50000
L48T8/840/15P-ID DE	F32T8	48	15	2200	146	120 - 277	4000	83+	50000
L48T8/850/15P-ID DE	F32T8	48	15	2200	146	120 - 277	5000	83+	50000
<b>Linear T5 HO</b>									
L48T5/830/25P-ID DE	F54T5HO	48	25	3500	140	120 - 277	3000	80+	50000
L48T5/830/25P-ID DE	F54T5HO	48	25	3500	140	120 - 277	3500	80+	50000
L48T5/830/25P-ID DE	F54T5HO	48	25	3500	140	120 - 277	4000	80+	50000
L48T5/830/25P-ID DE	F54T5HO	48	25	3500	140	120 - 277	5000	80+	50000

TYPE - B

## AC Direct | T8 Lamp | 0-10V Dimming | Single End Input



### FEATURES AND BENEFITS

- Single Ended Bypass Connectin with Non-Shunted Tombstones
- 0-10V Dimmable
- Internal Driver
- Glass Tube for Optimal Light Output and Heat Dissipation
- -20°F to 130°F Ambient Operating Temperature
- Frosted to Prevent Glare
- Suitable for Damp Locations
- 325° Wide Beam Angle
- 5 Year Warranty



**NO**  
Shunted  
Instant Start Socket



**YES**  
Unshunted  
Rapid Start Socket

### WIRING DIAGRAM



TYPE - B

Model No.	Replaces	Length (in)	Lamp Power (W)	Lumens (lm)	Lamp Efficacy (lm/W)	Input Voltage (V)	CCT (K)	CRI	Life (h)
<b>Linear T8</b>									
L24T8/830/9G-ID-10V	F17T8	24	9	1100	122	120 - 277	3000	83+	50000
L24T8/835/9G-ID-10V	F17T8	24	9	1100	122	120 - 277	3500	83+	50000
L24T8/840/9G-ID-10V	F17T8	24	9	1100	122	120 - 277	4000	83+	50000
L24T8/850/9G-ID-10V	F17T8	24	9	1100	122	120 - 277	5000	83+	50000
L36T8/830/12G-ID-10V <sup>1</sup>	F25T8	36	12	1400	117	120 - 277	3000	83+	50000
L36T8/835/12G-ID-10V <sup>1</sup>	F25T8	36	12	1400	117	120 - 277	3500	83+	50000
L36T8/840/12G-ID-10V <sup>1</sup>	F25T8	36	12	1400	117	120 - 277	4000	83+	50000
L36T8/850/12G-ID-10V <sup>1</sup>	F25T8	36	12	1400	117	120 - 277	5000	83+	50000
L48T8/830/14G-ID-10V	F32T8	48	14	1800	129	120 - 277	3000	83+	50000
L48T8/835/14G-ID-10V	F32T8	48	14	1800	129	120 - 277	3500	83+	50000
L48T8/840/14G-ID-10V	F32T8	48	14	1800	129	120 - 277	4000	83+	50000
L48T8/850/14G-ID-10V	F32T8	48	14	1800	129	120 - 277	5000	83+	50000
L48T8/830/17G-ID-10V	F32T8	48	18	2200	129	120 - 277	3000	83+	50000
L48T8/835/17G-ID-10V	F32T8	48	18	2200	129	120 - 277	3500	83+	50000
L48T8/840/17G-ID-10V	F32T8	48	18	2200	129	120 - 277	4000	83+	50000
L48T8/850/17G-ID-10V	F32T8	48	18	2200	129	120 - 277	5000	83+	50000

## AC Direct | T8 Lamp | Double End Input



## FEATURES AND BENEFITS

- Double Ended Bypass Connection with Shunted or Single End Bypass Connection with Non-Shunted Tombstones
- Internal Driver
- Glass Tube for Optimal Light Output and Heat Dissipation
- -20° F to 130° F Ambient Operating Temperature
- Instant on, No delay
- Convenient and quick installation
- Frosted to Prevent Glare
- Suitable for Damp Locations
- 325° Wide Beam Angle
- 5 Year Warranty

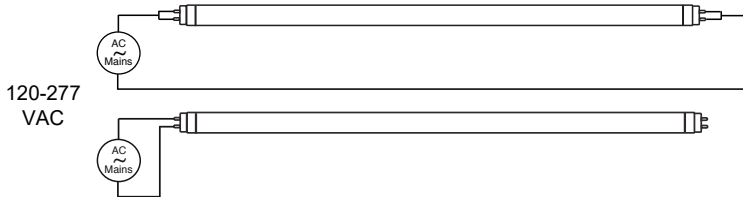

TYPE - B

Model No.	Replaces	Length (in)	Lamp Power (W)	Lumens (lm)	Lamp Efficacy (lm/W)	Input Voltage (V)	CCT (K)	CRI	Life (h)
<b>Linear T8</b>									

L24T8/8XX/9G-ID DE	F17T8	24	9	1100	122	120-277	3000-5000K	83+	50000
L36T8/8XX/12G-ID DE	F25T8	36	12	1400	117	120-277	3000-5000K	83+	50000

Above Products: 8XX equals 3000K, 3500K, 4000K or 5000K Transitioned to UniFlex Type A + B Solutions, See page 23

L48T8/830/10G-ID DE	F32T8	48	10.5	1600	152	120-277	3000	83+	50000
L48T8/835/10G-ID DE	F32T8	48	10.5	1600	152	120-277	3500	83+	50000
L48T8/840/10G-ID DE	F32T8	48	10.5	1600	152	120-277	4000	83+	50000
L48T8/850/10G-ID DE	F32T8	48	10.5	1600	152	120-277	5000	83+	50000
L48T8/830/12G-ID DE	F32T8	48	12	1850	154	120 - 277	3000	83+	50000
L48T8/835/12G-ID DE	F32T8	48	12	1850	154	120 - 277	3500	83+	50000
L48T8/840/12G-ID DE	F32T8	48	12	1850	154	120 - 277	4000	83+	50000
L48T8/850/12G-ID DE	F32T8	48	12	1850	154	120 - 277	5000	83+	50000
L48T8/830/15G-ID DE	F32T8	48	15	2200	146	120-277	3000	83+	50000
L48T8/835/15G-ID DE	F32T8	48	15	2200	146	120-277	3500	83+	50000
L48T8/840/15G-ID DE	F32T8	48	15	2200	146	120-277	4000	83+	50000
L48T8/850/15G-ID DE	F32T8	48	15	2200	146	120-277	5000	83+	50000

# Flex™ ArmorCoat™

AC Direct | Slimline T8 Lamps | Double End Input



## FEATURES AND BENEFITS

- Double Ended Bypass Connection
- Internal Driver
- **ArmorCoat™** Shatterproof Coating
- Glass Tube for Optimal Light Output and Heat Dissipation
- -20° F to 130° F Ambient Operating Temperature
- Bracket Included
- Frosted to Prevent Glare
- Suitable for Damp Locations
- 325° Wide Beam Angle
- 5 Year Warranty



## WIRING DIAGRAM

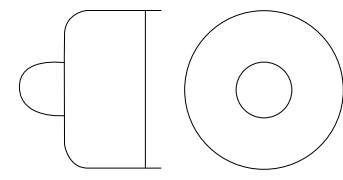
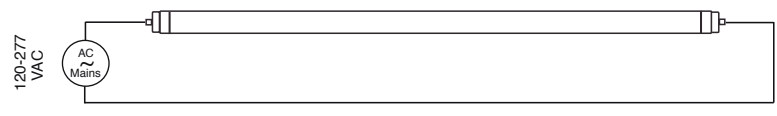

FA8 Base  
Single Pin

TYPE - B

Model No.	Base Type	Replaces	Length (in)	Lamp Power (W)	Lumens (lm)	Lamp Efficacy (lm/W)	Input Voltage (V)	CCT (K)	CRI	Life (h)
<b>Slimline Linear T8</b>										
L96T8/830/24G-ID DE	FA8	F96T8, F96T12	96	24	3500	146	120 - 277	3000	83+	50000
L96T8/835/24G-ID DE	FA8	F96T8, F96T12	96	24	3500	146	120 - 277	3500	83+	50000
L96T8/840/24G-ID DE	FA8	F96T8, F96T12	96	24	3500	146	120 - 277	4000	83+	50000
L96T8/850/24G-ID DE	FA8	F96T8, F96T12	96	24	3500	146	120 - 277	5000	83+	50000
L96T8/830/42G-ID DE	FA8	F96T8, F96T12	96	42	5500	131	120 - 277	3000	83+	50000
L96T8/835/42G-ID DE	FA8	F96T8, F96T12	96	42	5500	131	120 - 277	3500	83+	50000
L96T8/840/42G-ID DE	FA8	F96T8, F96T12	96	42	5500	131	120 - 277	4000	83+	50000
L96T8/850/42G-ID DE	FA8	F96T8, F96T12	96	42	5500	131	120 - 277	5000	83+	50000

Transitioned to UniFlex Type A + B Solutions, See page 24

# Flex™ ArmorCoat™



AC Direct | HO/VHO T8 Lamps | Double End Input



## FEATURES AND BENEFITS

- Double Ended Bypass Connection
- Internal Driver
- **ArmorCoat™** Shatterproof Coating
- Glass Tube for Optimal Light Output and Heat Dissipation
- -20° F to 130° F Ambient Operating Temperature
- Integrated Thermal Fuse Protection
- Frosted to Prevent Glare
- Suitable for Damp Locations
- 325° Wide Beam Angle
- 5 Year Warranty



## WIRING DIAGRAM

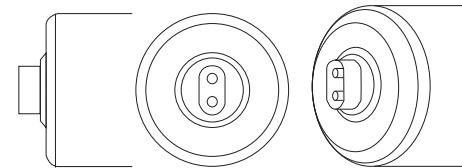
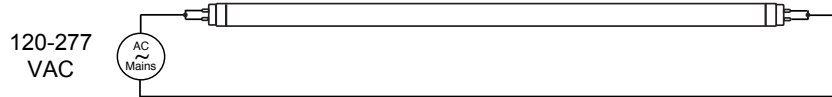

**R17d Base**  
Recessed Double Contact

TYPE - B

Model No.	Base Type	Replaces	Length (in)	Lamp Power (W)	Lumens (lm)	Lamp Efficacy (lm/W)	Input Voltage (V)	CCT (K)	CRI	Life (h)
<b>HO/VHO Linear T8</b>										
L96T8HO/830/42G-ID DE	R17d	F96T8, F96T12 HO/VHO	96	42	5500	131	120 - 277	3000 <sup>1</sup>	83+	50000
L96T8HO/835/42G-ID DE	R17d	F96T8, F96T12 HO/VHO	96	42	5500	131	120 - 277	3500	83+	50000
L96T8HO/840/42G-ID DE	R17d	F96T8, F96T12 HO/VHO	96	42	5500	131	120 - 277	4000	83+	50000
L96T8HO/850/42G-ID DE	R17d	F96T8, F96T12 HO/VHO	96	42	5500	131	120 - 277	5000	83+	50000

Transitioned to UniFlex Type A + B Solutions, See page 24

<sup>1</sup> May be subject to lead times and availability.

## AC Direct I LED FT Lamp I Single End Input



### FEATURES AND BENEFITS

- Internal Driver
- Smooth, Consistent Light
- UL for Safety
- No UV, No Mercury
- Long Life
- High CRI
- Instant on, no delay or warm up time
- Convenient and quick installation
- Utilizes current lamp sockets
- Compatible with controls and sensors
- -20° F to 130° F Ambient Operating Temperature
- 5 Year Warranty



TYPE - B

Model No.	Replaces	Lamp Power (W)	Lumens (lm)	Lamp Efficacy (lm/W)	Input Voltage (V)	CCT (K)	CRI	Life (h)
<b>Compact LED Lamps</b>								
LT18W/835-ID	FT18W	8	640	80	120 - 277	3500	83+	50000
LT18W/840-ID	FT18W	8	640	80	120 - 277	4000	83+	50000
LT18W/850-ID	FT18W	8	640	80	120 - 277	5000	83+	50000
LT24W/835-ID	FT24W	10	800	80	120 - 277	3500	83+	50000
LT24W/840-ID	FT24W	10	800	80	120 - 277	4000	83+	50000
LT24W/850-ID	FT24W	10	800	80	120 - 277	5000	83+	50000
LT36W/835-ID	FT36W	15	1200	80	120 - 277	3500	83+	50000
LT36W/840-ID	FT36W	15	1200	80	120 - 277	4000	83+	50000
LT36W/850-ID	FT36W	15	1200	80	120 - 277	5000	83+	50000
LT40W/835-ID	FT40W/FT55W	18	1800	80	120 - 277	3500	83+	50000
LT40W/840-ID	FT40W/FT55W	18	1800	80	120 - 277	4000	83+	50000
LT40W/850-ID	FT40W/FT55W	18	1800	80	120 - 277	5000	83+	50000

### WIRING DIAGRAM

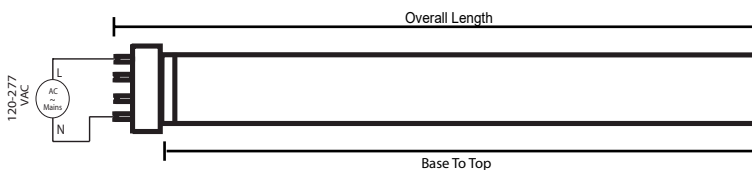

LT series	Overall Length (mm)	Base Face to Top (mm)
<b>Dimensions</b>		
LT40	540	493
LT36	421	374
LT24	326	278
LT18	231	183

## AC Direct Input Compact LED Lamps | Single End Input



### FEATURES AND BENEFITS

- Compatible with 2-Pin and 4-Pin Sockets
- Internal Driver
- -20° F to 130° F Ambient Operating Temperature
- Utilizes G24Q / G24D base
- Frosted to Prevent Glare
- Suitable for Damp Locations
- 5 Year Warranty
- Three Adjustable CCT (3000K, 3500K, 4000K)



Model No.	Replaces	Lamp Power (W)	Lumens (lm)	Lamp Efficacy (lm/W)	Input Voltage (V)	CCT (K)	CRI
<b>Compact LED Lamps</b>							
CLD18WH/8T-ID	18W, 26W, 32W, 42W CFQ	8.5	960/1020/1050	113/120/124	120 - 277	3000/3500/4000	83+
CLD18WV/8T-ID	18W, 26W, 32W, 42W CFQ	8.5	960/1020/1050	113/120/124	120 - 277	3000/3500/4000	83+



CLD18WH



CLD18WV

TYPE - B

### FEATURES AND BENEFITS

- Compatible with 2-Pin and 4-Pin Sockets
- Internal Driver
- -20° F to 130° F Ambient Operating Temperature
- Frosted to Prevent Glare
- Suitable for Damp Locations
- 5 Year Warranty



Model No.	Replaces	Lamp Power (W)	Lumens (lm)	Lamp Efficacy (lm/W)	Input Voltage (V)	CCT (K)	CRI	Life (h)
<b>Compact LED Lamps</b>								
CLD18WH/830-ID	18W, 26W, 32W, 42W CFQ	8	950	118	120 - 277	3000 <sup>1</sup>	83+	50000
CLD18WH/835-ID	18W, 26W, 32W, 42W CFQ	8	950	118	120 - 277	3500	83+	50000
CLD18WH/840-ID	18W, 26W, 32W, 42W CFQ	8	950	118	120 - 277	4000	83+	50000
CLD18WH/850-ID	18W, 26W, 32W, 42W CFQ	8	950	118	120 - 277	5000	83+	50000
CLD18WV/830-ID	18W, 26W, 32W, 42W CFQ	8	950	118	120 - 277	3000 <sup>1</sup>	83+	50000
CLD18WV/835-ID	18W, 26W, 32W, 42W CFQ	8	950	118	120 - 277	3500	83+	50000
CLD18WV/840-ID	18W, 26W, 32W, 42W CFQ	8	950	118	120 - 277	4000	83+	50000
CLD18WV/850-ID	18W, 26W, 32W, 42W CFQ	8	950	118	120 - 277	5000	83+	50000

<sup>1</sup> 3000K may be subject to lead times and availability.

## AC Direct Input | 360° Sign Lamps



### FEATURES AND BENEFITS

- Double-sided Design Sign Light
- 360° Beam Angle
- Rotatable End Caps
- Internal Driver
- Compatible with Sensors
- Instant On, No Delay or Warm Up Time
- Convenient and Quick Installation
- Input from Both Ends
- Utilizes R17d Sockets
- Works in Cold Temperature Applications
- Plastic tube is shatterproof
- No UV, No Mercury
- UL for Safety
- High CRI
- 5 Year Warranty



TYPE - B

Model No.	Length (in)	Base Type	Lamp Wattage	Input Voltage (V)	CCT (K)	Initial Lumens	CRI	Beam Angle	Lamp Efficacy (lm/W)	Power Factor	THD
<b>360° Sign Lamps</b>											
LS48T8HO/840/21P-ID DE	48	R17d	21	120 - 277	4000	2500	83+	360	120	>0.90	<20%
LS48T8HO/865/21P-ID DE	48	R17d	21	120 - 277	6500	2500	83+	360	120	>0.90	<20%
LS60T8HO/840/25P-ID DE	60	R17d	25	120 - 277	4000	3000	83+	360	120	>0.90	<20%
LS60T8HO/865/25P-ID DE	60	R17d	25	120 - 277	6500	3000	83+	360	120	>0.90	<20%
LS72T8HO/840/32P-ID DE	72	R17d	32	120 - 277	4000	3840	83+	360	120	>0.90	<20%
LS72T8HO/865/32P-ID DE	72	R17d	32	120 - 277	6500	3840	83+	360	120	>0.90	<20%
LS96T8HO/840/42P-ID DE	96	R17d	42	120 - 277	4000	5000	83+	360	120	>0.90	<20%
LS96T8HO/865/42P-ID DE	96	R17d	42	120 - 277	6500	5000	83+	360	120	>0.90	<20%

Available by request. Please inquire within.

### WIRING DIAGRAM

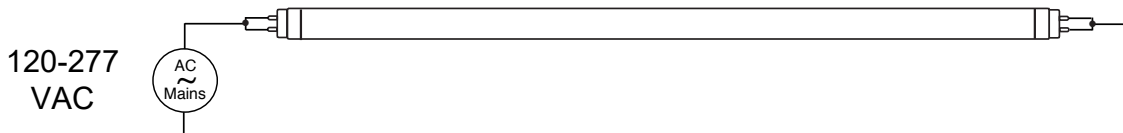

## Type B Emergency LED Inverter

### FEATURES AND BENEFITS

- Emergency Inverter for most Espen Type B lamps
- Dual Input Voltage (120/277V)
- 90 Minute Illumination Time
- 32 °F to 122 °F Ambient Operating Temperature
- 3 options with different sizes and wattage output
- Durable Steel Housing Contains LED Driver & Battery
- Suitable for Damp Locations
- LED Test Switch Included
- Does Not Affect Normal Operation
- 5 Year Limited Warranty



**VEMB5W**



- Espen Flex Type B: L48T5HE/8XX/12G-ID DE and T8 for 2ft, 3ft, 4ft. Also operated PL and PLL lamps.
- Provides 5W of power for a minimum of 90 minutes
- Lithium Ion Rechargeable Battery
- UL 924 & FCC Compliant
- Output OCV 200 VDC

**VEMB10W**



- Espen Flex Type B: T5, T8, 2ft, 3ft, and 4 ft and Uniflex (when used as Type B) lamps.
- Provides 10W of power for a minimum of 90 minutes
- Lithium Ion Rechargeable Battery
- UL 924 & FCC Compliant
- Output OCV 200 VDC

**VEMB20W**



- Espen Type B: PL, PLL, Uniflex (when used as Type B), and T8 and T5 HE lamps not exceeding 20W
- Illuminates Most LEDs at Full Brightness, up to 20W for a minimum of 90 minutes
- Nickel Cadmium Rechargeable Battery
- UL 924 NFPA 101 Life Safety Code, NEC OSHA Compliant
- Output OCV 320 VDC
- IC Rated

**VEMB8W-10V (S)**

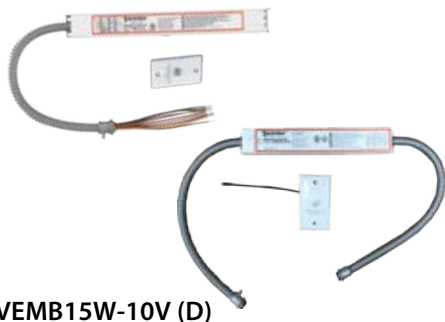

**VEMB15W-10V (D)**

- Emergency inverter for most Espen Type B lamps & 0-10V dimming luminaires
- Wide range input voltage of 120-347Vac, 50/60Hz
- 90 minutes minimum illumination time
- 5°C ~ 50°C (30°F ~ 122°F) Ambient operating temperature
- Constant power output
- Lithium-ion battery integrated
- Dual-end conduit for easy installation
- LED testing indicator included
- Self-testing monthly and yearly
- UL 924 listed and CEC Compliant
- 5 Year Warranty

TYPE - B

## Type B Emergency LED Inverter

Model No.	Input Voltage (V)	Output Voltage (V)	Output Power (W)
<b>Type B Emergency LED Driver</b>			
VEMB5W	120 - 277VAC	OCV 300VDC	5
VEMB10W	120 - 277VAC	OCV 200VDC	10
VEMB8W-10V (S)	120 - 347VAC	OCV 170VDC	8



### WIRING DIAGRAM

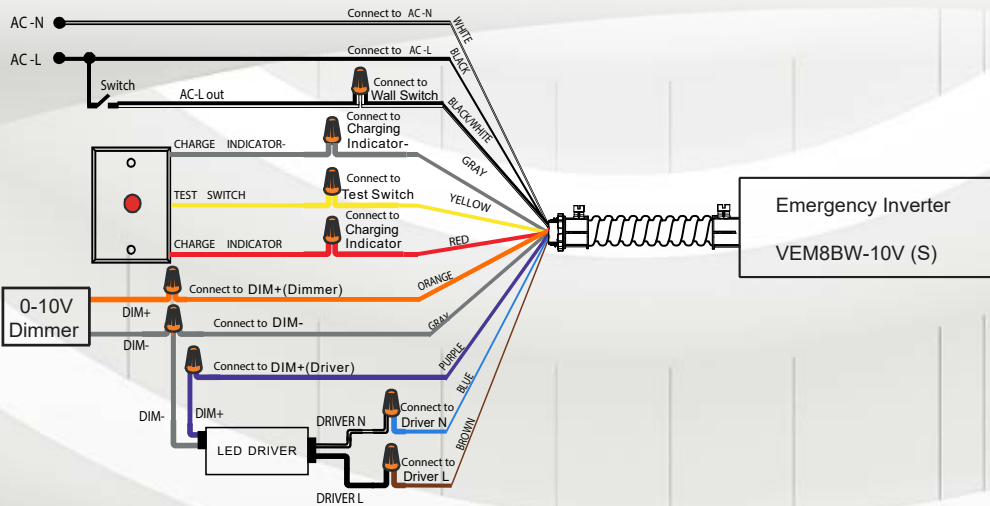
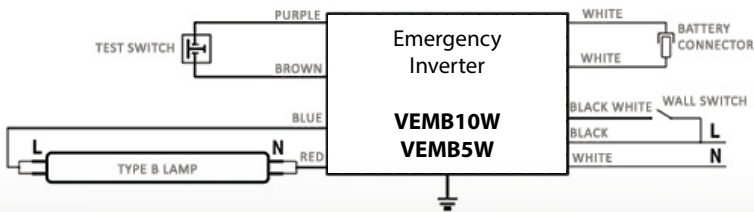

TYPE - B

### DIMENSIONS

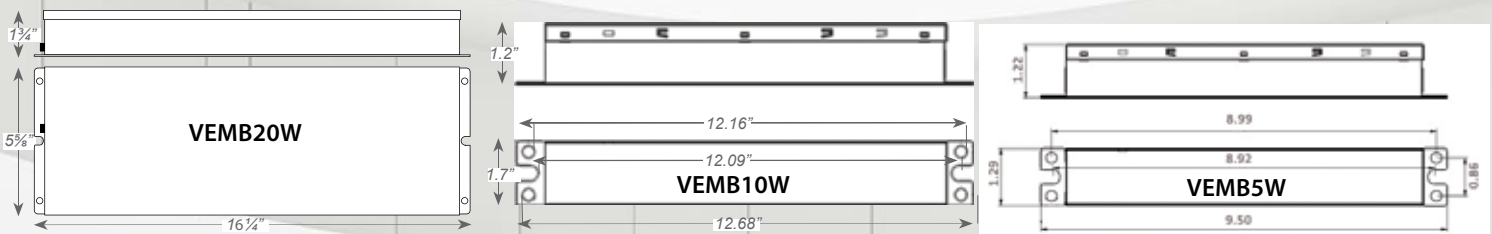

# UniFlex™

Type A + B LED T8 Lamps

## 8ft Slimline & HO Lamps <sup>LED</sup>

Compatible with Espen Ballast: VE259MVHIP and VE259120HIP  
 Easy Assembling from two sections of 4ft tube  
 ArmorCoat Shatterproof Coating



## U-Bent Lamps <sup>LED</sup>

Utilizes existing instant start or rapid start G13 sockets  
 High Performance Plastic Series  
 DLC Listed

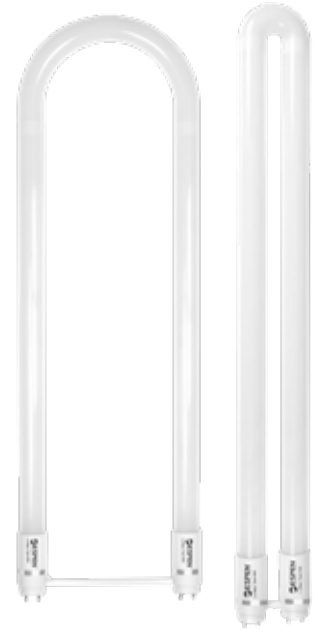

## Linear <sup>LED</sup>

Med. Bi-Pin, Dual Mode, DLC Listed, Convenient Wiring  
 Convenient Wiring, Long Life, Type A + B



**UniFlex™**  
 LED Solutions  
 Ballast Compatible  
 and AC Direct

## RetroFlex LED Driver <sup>LED</sup>

Dedicated Driver, Instant Start, Constant Current,  
 0-10V Dimming



## Emergency Inverter <sup>LED</sup>

90 Minute Illumination Time



### UniFlex - Type A+B Solution

UniFlex is a line of Hybrid Type A+B LED linear tubes, with industry-leading performance. The lamps can work with an existing fluorescent ballast, as 'plug-n-play', or directly on line voltage if the old ballast is bypassed. For Type A operation, the lamps work with fluorescent electronic ballasts, both instant start and programmed start. For Type B operation, UniFlex lamps have an internal driver that accepts 120-277 VAC, double-ended input. UniFlex works with existing instant start or rapid start sockets and are compatible with dimming ballasts, controls, and sensors. UniFlex lamps are offered in 2', 3', 4', U-Bent, and 8ft configurations.

TYPE A+B



### FEATURES AND BENEFITS

#### Type-A Application:

- Works on existing compatible Electronic Ballast
- Instant Start and Program Rapid Start Electronic Ballast

#### Type-B Application:

- Internal Drive To Be Wired Directly To Sockets
- 120 or 277 Volts Application
- See wiring diagram for Double Ended installation

- Long life | High CRI
- Instant on, No delay
- Convenient and quick installation
- Works with dimming ballast
- Compatible with controls and sensors
- Works in cold temperature applications
- 5 Year Warranty

### WIRING DIAGRAM

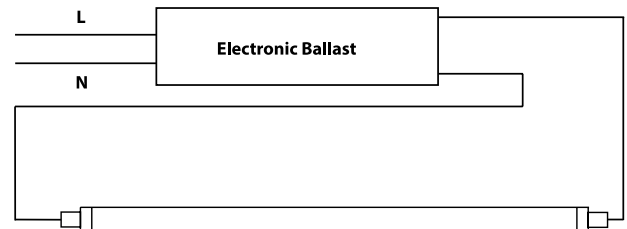

Model No.	Length (in)	Power Direct AC (W)	Power w/Ballast (W)	Input Voltage	CCT	Lumens (lm)	CRI	Beam Angle	Lamp Efficacy Direct AC	Lamp Efficacy w/Ballast	Life (h)
L24T8/830/9G-AB	24	9	12	120-277	3000 <sup>2</sup>	1350	83	325	150	112	50000
L24T8/835/9G-AB	24	9	12	120-277	3500	1350	83	325	150	112	50000
L24T8/840/9G-AB	24	9	12	120-277	4000	1350	83	325	150	112	50000
L24T8/850/9G-AB	24	9	12	120-277	5000	1350	83	325	150	112	50000
L36T8/830/11G-AB	36	11	14	120-277	3000 <sup>2</sup>	1650	83	325	150	115	50000
L36T8/835/11G-AB	36	11	14	120-277	3500	1650	83	325	150	115	50000
L36T8/840/11G-AB	36	11	14	120-277	4000	1650	83	325	150	115	50000
L36T8/850/11G-AB	36	11	14	120-277	5000	1650	83	325	150	115	50000
L48T8/830/12G-AB	48	12	15	120-277	3000 <sup>2</sup>	1800	83	325	150	120	50000
L48T8/835/12G-AB	48	12	15	120-277	3500	1800	83	325	150	120	50000
L48T8/840/12G-AB	48	12	15	120-277	4000	1800	83	325	150	120	50000
L48T8/850/12G-AB	48	12	15	120-277	5000	1800	83	325	150	120	50000

<sup>1</sup> See [espentech.com](http://espentech.com) for ballast compatibility list.

<sup>2</sup> 3000K may be subject to lead times and availability



### FEATURES AND BENEFITS

- Type A mode: Compatible with electronic ballast VE259MVHIP and VE259120HIP
- Type B mode: Internal Driver (Direct 120-277VAC input)
- Long Life
- High CRI
- Instant on, no delay or warm up time
- Convenient and quick installation
- Accessory: Fa8 and R17d End Cap Adapter Converter, Mounting Clip L96T8/8XX/24G-AB default Fa8, L96T8HO/8XX/42G-AB default R17d
- Easy Assembling from two sections of 4ft tube
- Works in cold temperature applications
- ArmorCoat | Shatterproof Coating
- Glass Tube for Optimal Light Output and Heat Diffusion
- 5 Year Warranty



Model No.	Length	Input Voltage	Power w/ Ballast (W)	CCT	Lumen (lm)	CRI	Beam Angle	Lamp Efficacy Direct AC (lm/W)	System Efficacy w/Ballast (lm/W)	Life (h)
L96T8/830/24G-AB	96	120-277V	24	28	3000k	3600	325	150	128	50000
L96T8/835/24G-AB	96	120-277V	24	28	3500k	3600	325	150	128	50000
L96T8/840/24G-AB	96	120-277V	24	28	4000k	3600	325	150	128	50000
L96T8/850/24G-AB	96	120-277V	24	28	5000k	3600	325	150	128	50000
L96T8HO/830/42G-AB	96	120-277V	42	45	3000k	5500	325	130	122	50000
L96T8HO/835/42G-AB	96	120-277V	42	45	3500k	5500	325	130	122	50000
L96T8HO/840/42G-AB	96	120-277V	42	45	4000k	5500	325	130	122	50000
L96T8HO/850/42G-AB	96	120-277V	42	45	5000k	5500	325	130	122	50000

### WIRING DIAGRAM

1-LAMP VE259MVHIP/VE250120HIP Wiring (Type A mode)

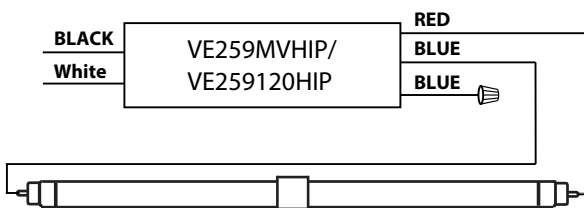

2-LAMP VE259MVHIP/VE250120HIP Wiring (Type A mode)

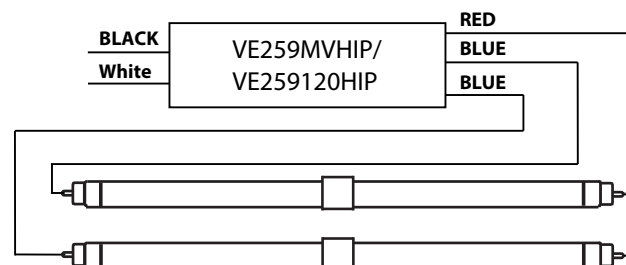



### FEATURES AND BENEFITS

- Type A and B Lamp
- Internal driver for direct 120-277 VAC Input
- Double ended Type-B Input
- Works with fluorescent electronic ballast (Instant Start and Programmed Start)
- Long life | High CRI
- Instant on, No delay
- Convenient and quick installation
- Utilizes existing instant start or rapid start sockets
- Works with dimming ballast
- Compatible with controls and sensors
- Works in cold temperature applications
- 5 Year Warranty

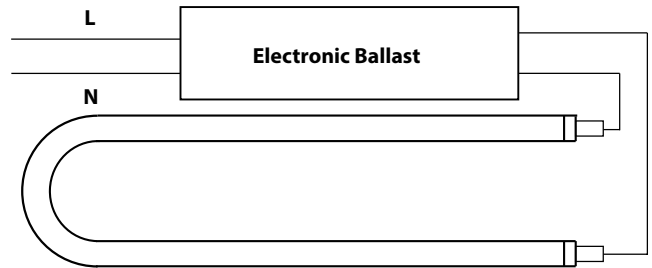
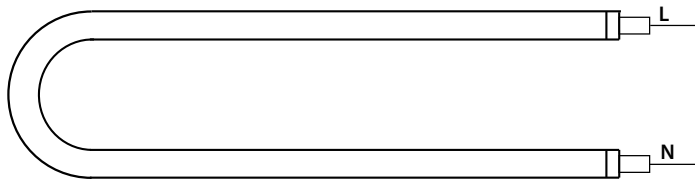

Model No.	Length (in)	Width (in)	Power Direct AC (W)	Power w/Ballast (W)	Input Voltage	CCT	Lumens (lm)	CRI	Beam Angle	Lamp Efficacy Direct AC	Lamp Efficacy w/Ballast	Life (h)
LB31T8U/830/13P-AB	24	1-5/8	13	16	120-277V	3000K	1800	83	240°	138	112.5	50000
LB31T8U/835/13P-AB	24	1-5/8	13	16	120-277V	3500K	1800	83	240°	138	112.5	50000
LB31T8U/840/13P-AB	24	1-5/8	13	16	120-277V	4000K	1800	83	240°	138	112.5	50000
LB31T8U/850/13P-AB	24	1-5/8	13	16	120-277V	5000K	1800	83	240°	138	112.5	50000
LB48T8U6/830/13P-AB	24	6	13	16	120-277V	3000K	1800	83	240°	138	128	50000
LB48T8U6/835/13P-AB	24	6	13	16	120-277V	3500K	1800	83	240°	138	128	50000
LB48T8U6/840/13P-AB	24	6	13	16	120-277V	4000K	1800	83	240°	138	128	50000
LB48T8U6/850/13P-AB	24	6	13	16	120-277V	5000K	1800	83	240°	138	128	50000

1 Calculation based on (lm/W)  
 2 See [espentech.com](http://espentech.com) for ballast compatibility list.  
 3 3000K CCT may be subject to lead times and availability

## Type A + B Emergency Solutions

### EMERGENCY BALLAST FEATURES AND BENEFITS

- Internal Driver
- Emergency ballasts for Type A Emergency Applications
- Dual Input Voltage (120/277V)
- May work with Fluorescents and Type A T5 or T8 LED lamps using ballasts\*
- Compatible with Espen Retroflex Lamps, Ballasts, and Type A drivers
- High Temperature Ni Cad Battery
- Durable, Heavy Duty Steel Housing
- 4 options with different sizes and lumen output
- Maintenance Free, Long Life
- 5 Year Warranty



Model No.	Type	Lumens	Voltage (V)	Operation Hours	Case
VEM500DV-L	Emergency Ballast <sup>1</sup>	500	120/277	90 mins	Regular
VEM800DV-L	Emergency Ballast <sup>1</sup>	800	120/277	90 mins	Slim
VEM1300DV-L	Emergency Ballast <sup>1</sup>	1300	120/277	90 mins	Slim

<sup>1</sup> When wired as Type A, use Emergency Ballast

**1 LAMP EMERGENCY**

VEM500DV-L



Regular Case      500 Lumens

VEM800DV-L



Slim Case      800 Lumens

**1-2 LAMP EMERGENCY**

VEM1300DV-L



Slim Case      1,300 Lumens

### EMERGENCY INVERTER FEATURES AND BENEFITS

**VEMB20W**



- Espen Type B: PL, PLL, Uniflex (when used as Type B<sup>1</sup>), and T8 and T5 HE lamps not exceeding 20W
- Illuminates Most LEDs at Full Brightness, up to 20W for a minimum of 90 minutes
- Nickel Cadmium Rechargeable Battery
- UL 924 NFPA 101 Life Safety Code, NEC OSHA Compliant
- Output OCV 320 VDC

<sup>1</sup> When wired as Type B, use Emergency Inverters.

*\*Note: Espen recommends testing compatibility and performance in the actual jobsite prior to purchasing and before the actual installation lamp, ballasts/drivers, and emergency ballasts combinations performs differently depending on the circuit designs, components used, and other factors that can affect compatibility and performance.*

LED LAMP WITH EXTERNAL DRIVER | Type C

TYPE - C



**driver** LED

Constant Current  
Multi-Channel 0-10V & power line dimming  
Field Adjustable through power line.

**linear** LED

G13 or G5, External Driver  
Dimmable, Long Life, Convenient Wiring



**CORETECH™LED**  
intelligent LED Solutions



**Emergency Inverter**

90 Minute Illumination Time

**ESPEN CORETECH LED SYSTEM**

LED lamps with external driver for full controllability ESPEN's CoreTech LED system consists of industry-leading LED lamps and programmable multi-channel drivers. The CoreTech system utilizes the exact same wiring diagram as fluorescent ballasts. The upgrade is handled the same as replacing an electronic ballast and lamps. Your facility can save up to 50% of system power while maintaining or increasing illumination levels.

The CoreTech multi-channel design permits all lamps to work independently to prevent total darkness when one lamp fails. The user-friendly programmability allows you to set the same system for normal output, high output, or low output, to match your application requirements.

LED T5 & T8 LAMP WITH EXTERNAL DRIVER | Type C



TYPE - C

FEATURES AND BENEFITS

- No Polarity, Lamp Ends Can Be Reversed
- Compatible with Controls and Sensors
- Glass Tube for Optimal Light Output and Heat Dissipation
- 50,000 Hours Life with No Limitation on On/Off Cycles
- -20° F to 130° F Ambient Operating Temperature
- 1 or 2 Lamps Compatible with Espen VPL50 LED Driver<sup>1</sup>
- 3 or 4 Lamps Compatible with Espen VPL100 LED Driver<sup>1</sup>
- 240° Wide Beam Angle for T5 Lamps
- 325° Wide Beam Angle for T8 Lamps
- Dimmable
- Class 2 System
- 5 Year Warranty



# LED T5 HE & HO LAMP WITH EXTERNAL DRIVER | Type C

TYPE - C

## For T5HE Replacement (250mA Driving Current)

Model No.	Length (in)	Driver Current	Replaces	Lamp Power (W)	System Power (W)	Lumens (lm)	Lamp Efficacy (lm/W)	Lamp Voltage (V)	CCT (K)	CRI	Life (h)	Current Settings
Linear T5												
L24T5/830/11G-XT	24	Normal	F14T5HE	8	11	1200	150	120-277	3000	82+	50000	250 mA
L24T5/835/11G-XT	24	Normal	F14T5HE	8	11	1200	150	120-277	3500	82+	50000	250 mA
L24T5/840/11G-XT	24	Normal	F14T5HE	8	11	1200	150	120-277	4000	82+	50000	250 mA
L24T5/850/11G-XT	24	Normal	F14T5HE	8	11	1200	150	120-277	5000	82+	50000	250 mA
L36T5/830/18G-XT	36	Normal	F21T5HE	9	12	1400	155	120-277	3000	82+	50000	250 mA
L36T5/835/18G-XT	36	Normal	F21T5HE	9	12	1400	155	120-277	3500	82+	50000	250 mA
L36T5/840/18G-XT	36	Normal	F21T5HE	9	12	1400	155	120-277	4000	82+	50000	250 mA
L36T5/850/18G-XT	36	Normal	F21T5HE	9	12	1400	155	120-277	5000	82+	50000	250 mA
L48T5/830/24G-XT	48	Normal	F28T5HE	11	14	1700	155	120-277	3000	82+	50000	250 mA
L48T5/835/24G-XT	48	Normal	F28T5HE	11	14	1700	155	120-277	3500	82+	50000	250 mA
L48T5/840/24G-XT	48	Normal	F28T5HE	11	14	1700	155	120-277	4000	82+	50000	250 mA
L48T5/850/24G-XT	48	Normal	F28T5HE	11	14	1700	155	120-277	5000	82+	50000	250 mA

## For T5HE Replacement (360mA Driving Current)

Model No.	Length (in)	Driver Current	Replaces	Lamp Power (W)	System Power (W)	Lumens (lm)	Lamp Efficacy (lm/W)	Lamp Voltage (V)	CCT (K)	CRI	Life (h)	Current Settings
Linear T5												
L24T5/830/11G-XT	24	Normal	F14T5HE	9	12	1300	144	120-277	3000	82+	50000	360mA
L24T5/835/11G-XT	24	Normal	F14T5HE	9	12	1300	144	120-277	3500	82+	50000	360mA
L24T5/840/11G-XT	24	Normal	F14T5HE	9	12	1300	144	120-277	4000	82+	50000	360mA
L24T5/850/11G-XT	24	Normal	F14T5HE	9	12	1300	144	120-277	5000	82+	50000	360mA
L36T5/830/18G-XT	36	Normal	F21T5HE	13	16	1900	146	120-277	3000	82+	50000	360mA
L36T5/835/18G-XT	36	Normal	F21T5HE	13	16	1900	146	120-277	3500	82+	50000	360mA
L36T5/840/18G-XT	36	Normal	F21T5HE	13	16	1900	146	120-277	4000	82+	50000	360mA
L36T5/850/18G-XT	36	Normal	F21T5HE	13	16	1900	146	120-277	5000	82+	50000	360mA
L48T5/830/24G-XT	48	Normal	F28T5HE	15	18	2200	146	120-277	3000	82+	50000	360mA
L48T5/835/24G-XT	48	Normal	F28T5HE	15	18	2200	146	120-277	3500	82+	50000	360mA
L48T5/840/24G-XT	48	Normal	F28T5HE	15	18	2200	146	120-277	4000	82+	50000	360mA
L48T5/850/24G-XT	48	Normal	F28T5HE	15	18	2200	146	120-277	5000	82+	50000	360mA

## For T5HO Replacement (500mA Driving Current)

Model No.	Length (in)	Driver Current	Replaces	Lamp Power (W)	System Power (W)	Lumens (lm)	Lamp Efficacy (lm/W)	Lamp Voltage (V)	CCT (K)	CRI	Life (h)	Current Settings
Linear T5												
L24T5/830/11G-XT	24	High	F24T5HO	12	15	1700	142	120-277	3000	82+	50000	500mA
L24T5/835/11G-XT	24	High	F24T5HO	12	15	1700	142	120-277	3500	82+	50000	500mA
L24T5/840/11G-XT	24	High	F24T5HO	12	15	1700	142	120-277	4000	82+	50000	500mA
L24T5/850/11G-XT	24	High	F24T5HO	12	15	1700	142	120-277	5000	82+	50000	500mA
L36T5/830/18G-XT	36	High	F39T5HO	18	21	2500	139	120-277	3000	82+	50000	500mA
L36T5/835/18G-XT	36	High	F39T5HO	18	21	2500	139	120-277	3500	82+	50000	500mA
L36T5/840/18G-XT	36	High	F39T5HO	18	21	2500	139	120-277	4000	82+	50000	500mA
L36T5/850/18G-XT	36	High	F39T5HO	18	21	2500	139	120-277	5000	82+	50000	500mA
L48T5/830/24G-XT	48	High	F54T5HO	24	27	3300	138	120-277	3000	82+	50000	500mA
L48T5/835/24G-XT	48	High	F54T5HO	24	27	3300	138	120-277	3500	82+	50000	500mA
L48T5/840/24G-XT	48	High	F54T5HO	24	27	3300	138	120-277	4000	82+	50000	500mA
L48T5/850/24G-XT	48	High	F54T5HO	24	27	3300	138	120-277	5000	82+	50000	500mA

## LED T5 HE & HO NANO PLASTIC LAMP WITH EXTERNAL DRIVER

### For T5HE Replacement (250mA Driving Current)

Model No.	Length (in)	Driver Current	Replaces	Lamp Power (W)	System Power (W)	Lumens (lm)	Lamp Efficacy (lm/W)	Lamp Voltage (V)	CCT (K)	CRI	Life (h)	Current Settings
<b>Linear T5</b>												
L24T5/830/11P-XT	24	Normal	F14T5HE	8	11	1200	109	120-277	3000	82+	50000	250 mA
L24T5/835/11P-XT	24	Normal	F14T5HE	8	11	1200	109	120-277	3500	82+	50000	250 mA
L24T5/840/11P-XT	24	Normal	F14T5HE	8	11	1200	109	120-277	4000	82+	50000	250 mA
L24T5/850/11P-XT	24	Normal	F14T5HE	8	11	1200	109	120-277	5000	82+	50000	250 mA
L36T5/830/18P-XT	36	Normal	F21T5HE	9	12	1410	118	120-277	3000	82+	50000	250 mA
L36T5/835/18P-XT	36	Normal	F21T5HE	9	12	1410	118	120-277	3500	82+	50000	250 mA
L36T5/840/18P-XT	36	Normal	F21T5HE	9	12	1410	118	120-277	4000	82+	50000	250 mA
L36T5/850/18P-XT	36	Normal	F21T5HE	9	12	1410	118	120-277	5000	82+	50000	250 mA
L48T5/830/24P-XT	48	Normal	F28T5HE	11	14	1700	122	120-277	3000	82+	50000	250 mA
L48T5/835/24P-XT	48	Normal	F28T5HE	11	14	1700	122	120-277	3500	82+	50000	250 mA
L48T5/840/24P-XT	48	Normal	F28T5HE	11	14	1700	122	120-277	4000	82+	50000	250 mA
L48T5/850/24P-XT	48	Normal	F28T5HE	11	14	1700	122	120-277	5000	82+	50000	250 mA

TYPE - C

### For T5HE Replacement (360mA Driving Current)

Model No.	Length (in)	Driver Current	Replaces	Lamp Power (W)	System Power (W)	Lumens (lm)	Lamp Efficacy (lm/W)	Lamp Voltage (V)	CCT (K)	CRI	Life (h)	Current Settings
<b>Linear T5</b>												
L24T5/830/11P-XT	24	Normal	F14T5HE	9	12	1300	144	120-277	3000	82+	50000	360mA
L24T5/835/11P-XT	24	Normal	F14T5HE	9	12	1300	144	120-277	3500	82+	50000	360mA
L24T5/840/11P-XT	24	Normal	F14T5HE	9	12	1300	144	120-277	4000	82+	50000	360mA
L24T5/850/11P-XT	24	Normal	F14T5HE	9	12	1300	144	120-277	5000	82+	50000	360mA
L36T5/830/18P-XT	36	Normal	F21T5HE	13	16	1900	146	120-277	3000	82+	50000	360mA
L36T5/835/18P-XT	36	Normal	F21T5HE	13	16	1900	146	120-277	3500	82+	50000	360mA
L36T5/840/18P-XT	36	Normal	F21T5HE	13	16	1900	146	120-277	4000	82+	50000	360mA
L36T5/850/18P-XT	36	Normal	F21T5HE	13	16	1900	146	120-277	5000	82+	50000	360mA
L48T5/830/24P-XT	48	Normal	F28T5HE	15	18	2300	153	120-277	3000	82+	50000	360mA
L48T5/835/24P-XT	48	Normal	F28T5HE	15	18	2300	153	120-277	3500	82+	50000	360mA
L48T5/840/24P-XT	48	Normal	F28T5HE	15	18	2300	153	120-277	4000	82+	50000	360mA
L48T5/850/24P-XT	48	Normal	F28T5HE	15	18	2300	153	120-277	5000	82+	50000	360mA

### For T5HO Replacement (500mA Driving Current)

Model No.	Length (in)	Driver Current	Replaces	Lamp Power (W)	System Power (W)	Lumens (lm)	Lamp Efficacy (lm/W)	Lamp Voltage (V)	CCT (K)	CRI	Life (h)	Current Settings
<b>Linear T5</b>												
L24T5/830/11P-XT	24	High	F24T5HO	12	15	1700	142	120-277	3000	82+	50000	500mA
L24T5/835/11P-XT	24	High	F24T5HO	12	15	1700	142	120-277	3500	82+	50000	500mA
L24T5/840/11P-XT	24	High	F24T5HO	12	15	1700	142	120-277	4000	82+	50000	500mA
L24T5/850/11P-XT	24	High	F24T5HO	12	15	1700	142	120-277	5000	82+	50000	500mA
L36T5/830/18P-XT	36	High	F39T5HO	18	21	2500	139	120-277	3000	82+	50000	500mA
L36T5/835/18P-XT	36	High	F39T5HO	18	21	2500	139	120-277	3500	82+	50000	500mA
L36T5/840/18P-XT	36	High	F39T5HO	18	21	2500	139	120-277	4000	82+	50000	500mA
L36T5/850/18P-XT	36	High	F39T5HO	18	21	2500	139	120-277	5000	82+	50000	500mA
L48T5/830/24P-XT	48	High	F54T5HO	24	27	3300	138	120-277	3000	82+	50000	500mA
L48T5/835/24P-XT	48	High	F54T5HO	24	27	3300	138	120-277	3500	82+	50000	500mA
L48T5/840/24P-XT	48	High	F54T5HO	24	27	3300	138	120-277	4000	82+	50000	500mA
L48T5/850/24P-XT	48	High	F54T5HO	24	27	3300	138	120-277	5000	82+	50000	500mA

# LED T8 LAMP WITH EXTERNAL DRIVER | Type C

TYPE - C

## Low Output (250mA Driving Current)

Model No.	Length (in)	Driver Current	Replaces	Lamp Power (W)	System Power (W)	Lumens (lm)	Lamp Efficacy (lm/W)	Lamp Voltage (V)	CCT (K)	CRI	Life (h)	Current Settings
Linear T8												
L24T8/830/8G-XT	24	Normal	F17T8	8	11	1200	150	120-277	3000+	82+	50000	250mA
L24T8/835/8G-XT	24	Normal	F17T8	8	11	1200	150	120-277	3500	82+	50000	250mA
L24T8/840/8G-XT	24	Normal	F17T8	8	11	1200	150	120-277	4000	82+	50000	250mA
L24T8/850/8G-XT	24	Normal	F17T8	8	11	1200	150	120-277	5000	82+	50000	250mA
L36T8/830/11G-XT	36	Normal	F25T8	9	12	1400	155	120-277	3000+	82+	50000	250mA
L36T8/835/11G-XT	36	Normal	F25T8	9	12	1400	155	120-277	3500	82+	50000	250mA
L36T8/840/11G-XT	36	Normal	F25T8	9	12	1400	155	120-277	4000	82+	50000	250mA
L36T8/850/11G-XT	36	Normal	F25T8	9	12	1400	155	120-277	5000	82+	50000	250mA
L48T8/830/15G-XT	48	Normal	F32T8	10	13	1600	160	120-277	3000+	82+	50000	250mA
L48T8/835/15G-XT	48	Normal	F32T8	10	13	1600	160	120-277	3500	82+	50000	250mA
L48T8/840/15G-XT	48	Normal	F32T8	10	13	1600	160	120-277	4000	82+	50000	250mA
L48T8/850/15G-XT	48	Normal	F32T8	10	13	1600	160	120-277	5000	82+	50000	250mA

## Normal Output (300mA Driving Current)

Model No.	Length (in)	Driver Current	Replaces	Lamp Power (W)	System Power (W)	Lumens (lm)	Lamp Efficacy (lm/W)	Lamp Voltage (V)	CCT (K)	CRI	Life (h)	Current Settings
Linear T8												
L24T8/830/8G-XT	24	Normal	F17T8	9	12	1300	144	120-277	3000+	82+	50000	300mA
L24T8/835/8G-XT	24	Normal	F14T8	9	12	1300	144	120-277	3500	82+	50000	300mA
L24T8/840/8G-XT	24	Normal	F17T8	9	12	1300	144	120-277	4000	82+	50000	300mA
L24T8/850/8G-XT	24	Normal	F14T8	9	12	1300	144	120-277	5000	82+	50000	300mA
L36T8/830/11G-XT	36	Normal	F25T8	11	14	1600	145	120-277	3000+	82+	50000	300mA
L36T8/835/11G-XT	36	Normal	F25T8	11	14	1600	145	120-277	3500	82+	50000	300mA
L36T8/840/11G-XT	36	Normal	F25T8	11	14	1600	145	120-277	4000	82+	50000	300mA
L36T8/850/11G-XT	36	Normal	F25T8	11	14	1600	145	120-277	5000	82+	50000	300mA
L48T8/830/15G-XT	48	Normal	F32T8	12	15	1800	150	120-277	3000+	82+	50000	300mA
L48T8/835/15G-XT	48	Normal	F32T8	12	15	1800	150	120-277	3500	82+	50000	300mA
L48T8/840/15G-XT	48	Normal	F32T8	12	15	1800	150	120-277	4000	82+	50000	300mA
L48T8/850/15G-XT	48	Normal	F32T8	12	15	1800	150	120-277	5000	82+	50000	300mA

## High Output (360mA Driving Current)

Model No.	Length (in)	Driver Current	Replaces	Lamp Power (W)	System Power (W)	Lumens (lm)	Lamp Efficacy (lm/W)	Lamp Voltage (V)	CCT (K)	CRI	Life (h)	Current Settings
Linear T8												
L24T8/830/8G-XT	24	High	F17T8	11	14	1600	145	120-277	3000+	82+	50000	360mA
L24T8/835/8G-XT	24	High	F14T8	11	14	1600	145	120-277	3500	82+	50000	360mA
L24T8/840/8G-XT	24	High	F17T8	11	14	1600	145	120-277	4000	82+	50000	360mA
L24T8/850/8G-XT	24	High	F14T8	11	14	1600	145	120-277	5000	82+	50000	360mA
L36T8/830/11G-XT	36	High	F25T8	13	16	1900	146	120-277	3000+	82+	50000	360mA
L36T8/835/11G-XT	36	High	F25T8	13	16	1900	146	120-277	3500	82+	50000	360mA
L36T8/840/11G-XT	36	High	F25T8	13	16	1900	146	120-277	4000	82+	50000	360mA
L36T8/850/11G-XT	36	High	F25T8	13	16	1900	146	120-277	5000	82+	50000	360mA
L48T8/830/15G-XT	48	High	F32T8	15	18	2200	146	120-277	3000+	82+	50000	360mA
L48T8/835/15G-XT	48	High	F32T8	15	18	2200	146	120-277	3500	82+	50000	360mA
L48T8/840/15G-XT	48	High	F32T8	15	18	2200	146	120-277	4000	82+	50000	360mA
L48T8/850/15G-XT	48	High	F32T8	15	18	2200	146	120-277	5000	82+	50000	360mA

# LED T8 NANO PLASTIC LAMP WITH EXTERNAL DRIVER | Type C

## Low Output (250mA Driving Current)

Model No.	Length (in)	Driver Current	Replaces	Lamp Power (W)	System Power (W)	Lumens (lm)	Lamp Efficacy (lm/W)	Lamp Voltage (V)	CCT (K)	CRI	Life (h)	Current Settings
<b>Linear T8</b>												
L24T8/830/8P-XT	24	Normal	F17T8	8	11	1200	150	120-277	3000	82+	50000	250mA
L24T8/835/8P-XT	24	Normal	F17T8	8	11	1200	150	120-277	3500	82+	50000	250mA
L24T8/840/8P-XT	24	Normal	F17T8	8	11	1200	150	120-277	4000	82+	50000	250mA
L24T8/850/8P-XT	24	Normal	F17T8	8	11	1200	150	120-277	5000	82+	50000	250mA
L36T8/830/11P-XT	36	Normal	F25T8	9	12	1400	156	120-277	3000	82+	50000	250mA
L36T8/835/11P-XT	36	Normal	F25T8	9	12	1400	156	120-277	3500	82+	50000	250mA
L36T8/840/11P-XT	36	Normal	F25T8	9	12	1400	156	120-277	4000	82+	50000	250mA
L36T8/850/11P-XT	36	Normal	F25T8	9	12	1400	156	120-277	5000	82+	50000	250mA
L48T8/830/15P-XT	48	Normal	F32T8	10	13	1600	160	120-277	3000	82+	50000	250mA
L48T8/835/15P-XT	48	Normal	F32T8	10	13	1600	160	120-277	3500	82+	50000	250mA
L48T8/840/15P-XT	48	Normal	F32T8	10	13	1600	160	120-277	4000	82+	50000	250mA
L48T8/850/15P-XT	48	Normal	F32T8	10	13	1600	160	120-277	5000	82+	50000	250mA

## Normal Output (300mA Driving Current)

Model No.	Length (in)	Driver Current	Replaces	Lamp Power (W)	System Power (W)	Lumens (lm)	Lamp Efficacy (lm/W)	Lamp Voltage (V)	CCT (K)	CRI	Life (h)	Current Settings
<b>Linear T8</b>												
L24T8/830/8P-XT	24	Normal	F17T8	9	12	1300	144	120-277	3000	82+	50000	300mA
L24T8/835/8P-XT	24	Normal	F17T8	9	12	1300	144	120-277	3500	82+	50000	300mA
L24T8/840/8P-XT	24	Normal	F17T8	9	12	1300	144	120-277	4000	82+	50000	300mA
L24T8/850/8P-XT	24	Normal	F17T8	9	12	1300	144	120-277	5000	82+	50000	300mA
L36T8/830/11P-XT	36	Normal	F25T8	11	14	1600	145	120-277	3000	82+	50000	300mA
L36T8/835/11P-XT	36	Normal	F25T8	11	14	1600	145	120-277	3500	82+	50000	300mA
L36T8/840/11P-XT	36	Normal	F25T8	11	14	1600	145	120-277	4000	82+	50000	300mA
L36T8/850/11P-XT	36	Normal	F25T8	11	14	1600	145	120-277	5000	82+	50000	300mA
L48T8/830/15P-XT	48	Normal	F32T8	12	15	1800	150	120-277	3000	82+	50000	300mA
L48T8/835/15P-XT	48	Normal	F32T8	12	15	1800	150	120-277	3500	82+	50000	300mA
L48T8/840/15P-XT	48	Normal	F32T8	12	15	1800	150	120-277	4000	82+	50000	300mA
L48T8/850/15P-XT	48	Normal	F32T8	12	15	1800	150	120-277	5000	82+	50000	300mA

## High Output (360mA Driving Current)

Model No.	Length (in)	Driver Current	Replaces	Lamp Power (W)	System Power (W)	Lumens (lm)	Lamp Efficacy (lm/W)	Lamp Voltage (V)	CCT (K)	CRI	Life (h)	Current Settings
<b>Linear T8</b>												
L24T8/830/8P-XT	24	High	F17T8	11	14	1600	145	120-277	3000	82+	50000	360mA
L24T8/835/8P-XT	24	High	F14T8	11	14	1600	145	120-277	3500	82+	50000	360mA
L24T8/840/8P-XT	24	High	F17T8	11	14	1600	145	120-277	4000	82+	50000	360mA
L24T8/850/8P-XT	24	High	F14T8	11	14	1600	145	120-277	5000	82+	50000	360mA
L36T8/830/11P-XT	36	High	F25T8	13	16	1900	146	120-277	3000	82+	50000	360mA
L36T8/835/11P-XT	36	High	F25T8	13	16	1900	146	120-277	3500	82+	50000	360mA
L36T8/840/11P-XT	36	High	F25T8	13	16	1900	146	120-277	4000	82+	50000	360mA
L36T8/850/11P-XT	36	High	F25T8	13	16	1900	146	120-277	5000	82+	50000	360mA
L48T8/830/15P-XT	48	High	F32T8	15	18	2200	147	120-277	3000	82+	50000	360mA
L48T8/835/15P-XT	48	High	F32T8	15	18	2200	147	120-277	3500	82+	50000	360mA
L48T8/840/15P-XT	48	High	F32T8	15	18	2200	147	120-277	4000	82+	50000	360mA
L48T8/850/15P-XT	48	High	F32T8	15	18	2200	147	120-277	5000	82+	50000	360mA

TYPE - C

# Field Adjustable Selectable Driver for Type-C LED's | Type C

TYPE - C



## FEATURES AND BENEFITS



- 3-Level Selectable Drive Current (250/ 300-360mA)
- Universal Voltage (120 - 277V)
- Multiple Output Channels
- Constant Current
- Output Current 250mA/300mA/360mA  
Selectable through Line Lead
- 0-10V Dimmable
- Integrates with Adaptive Lightning Control Systems
- Compatible with LED modules and Coretech LED tubes
- UL, cUL, UL8750 Class 2
- FCC Part 15 Class A



- 3-Level Selectable Drive Current (250/ 300-360mA)
- Universal Voltage (120-277V)
- Multiple Output Channels
- Constant Current | 4 Channels
- Output Current 250mA/300mA/360mA  
Selectable through Line Lead
- 0-10V Dimmable
- Integrates with Adaptive Lightning Control Systems
- Compatible with LED modules and Coretech LED tubes
- UL, cUL, UL8750 Class 2
- FCC Part 15 Class A

### 2 LAMP WIRING DIAGRAM

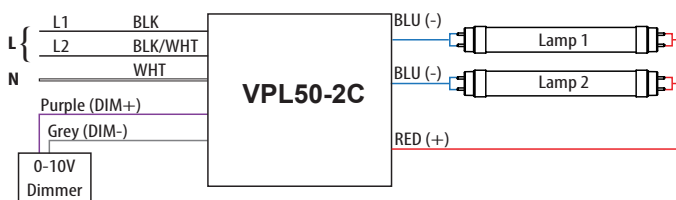

### 4 LAMP WIRING DIAGRAM

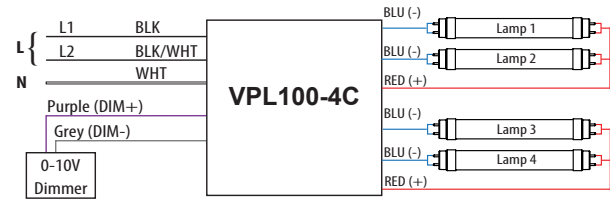

Model No.	Output Current	Driver Type	Max Wattage (W)	No. of Channels	Input Voltage (V)	Dimming
Programmable LED Driver						
VPL50-2C-025/030/036	Field Adjustable	Constant Current	36	2	120 - 277	0-10V
VPL100-4C-025/030/036	Field Adjustable	Constant Current	73	4	120 - 277	0-10V

See [espentech.com](http://espentech.com) for CoreTech™ and VersaLinear™ specifications.

## Field Adjustable Selectable Driver for Type-C LED's | Type C



VPL50

### FEATURES AND BENEFITS

- 3-Level Selectable Drive Current (250/ 360/ 500 mA)
- Universal Voltage (120 - 277V)
- Multiple Output Channels
- Constant Current
- Output Current 250mA/360mA/500mA Selectable through Line Lead
- 0-10V Dimmable
- Integrates with Adaptive Lightning Control Systems
- Compatible with LED modules and Coretech LED tubes
- UL, cUL, UL8750 Class 2
- FCC Part 15 Class A

TYPE - C

### 2 LAMP WIRING DIAGRAM

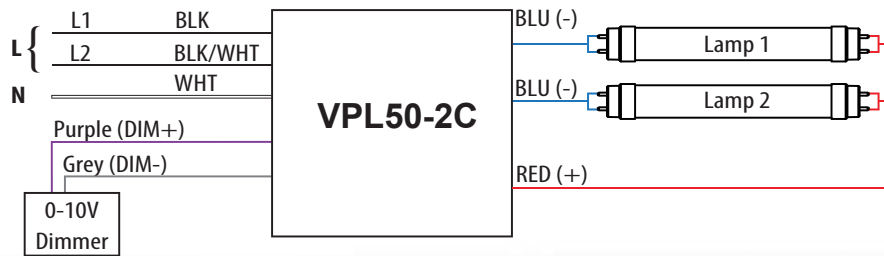

\*Dual-Relay Output Current Selection

Input Line	Output Current
L2 (BLK/WHT)	250mA
L1 (BLK)	360mA
L1 + L2	500mA

Model No.	Output Current	Driver Type	Max Wattage (W)	No. of Channels	Input Voltage (V)	Dimming
Programmable LED Driver						
VPL50-2C-025/030/050	Field Adjustable	Constant Current	50	2	120 - 277	0 - 10V

See [espentech.com](http://espentech.com) for CoreTech™ and VersaLinear™ specifications.



## Emergency Inverter

TYPE - C

### FEATURES AND BENEFITS

- Universal 120-347V AC, 50/60Hz Input
- Open Circuit Voltage 170VDC
- Charge/Power "ON" LED Indicator Light and Push-to-Test Switch for Code Compliance Testing
- Long Life, Maintenance Free, Lithium-Ion Battery
- Output Short and Overcurrent Protection: Electronic Limiting, with Normal Operation Resuming
- 90 Minute Minimum Emergency Operating Time Over Full Temperature Range
- Durable Steel Housing contains LED Driver and Battery
- 24 Hour Maximum Battery Recharge Time
- Major application includes commercial downlight and 0-10V fixtures
- 5 Year Warranty
- Meets UL924
- IC Rated

### VEMB15W-10V (D)



### VEMB8W-10V (S)

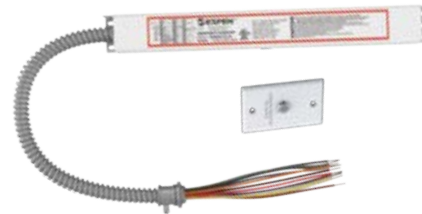

### DIMENSIONS

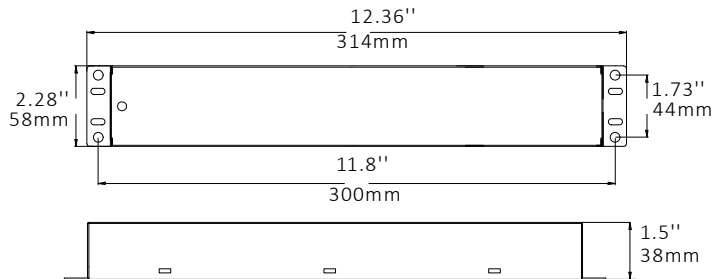

Model No.	Description
VEMB15W-10V (D)	Operates Espen Commercial Downlight or 0-10V Dimming Fixture up to 50W
VEMB8W-10V (S)	Operates Espen Commercial Downlight or 0-10V Dimming Fixture up to 80W

### WIRING DIAGRAM

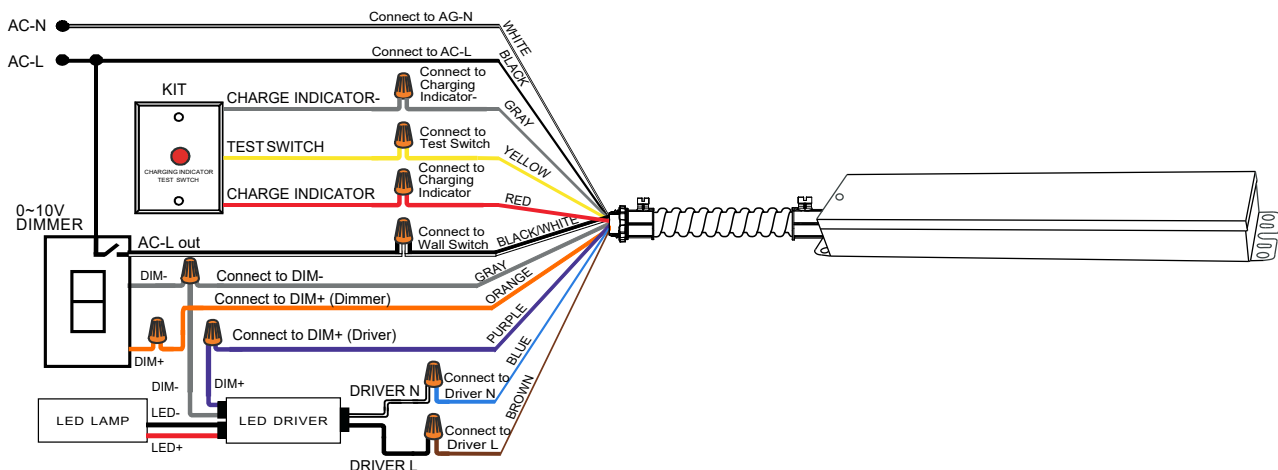



### versaLinear<sup>LED</sup>

Designed to Achieve High Lumen Output  
Each Kit Includes LED Modules Paired  
with an LED Driver  
Available in HE



### Commercial Downlight

LED Center Basket  
Available in 2' x 2' and 2' x 4' Sizes



### Troffer Kit<sup>LED</sup>

LED Center Basket  
Available in 2' x 2' and 2' x 4' Sizes



### Panel Kit<sup>LED</sup>

Ultra-Thin LED Panel  
Available in 2' x 2' and 2' x 4' Sizes



### Channel Kit<sup>LED</sup>

High Efficiency LED Module & LED Driver  
Provides Uniform Ambient Lighting



### versaKIT Strips<sup>LED</sup>

Converts 8ft T12 or T8 Fluorescent  
Strip Lights to the latest 4ft LED Technology  
Holds Two Rows of Two LED T8 Lamps  
Compatible with Type-A, Type-B, & Type-C Lamps for Rebate Programs



### Emergency Inverter

Suitable for LED Type B or A+B lamps, retrofit kits  
and LED fixtures, esp. integrated fixtures  
Powers up the whole fixture

### LED Retrofit Solutions

The VersaKit family include more than 50 models of LED Linear retrofit kits. Many of the VersaKit retrofit kits create the look of a completely new fixture, but without the labor of replacing the fixture. Utilizing the existing housing drops installation time to just minutes, and the ceiling doesn't need to be disturbed. The VersaKit retrofit kit family includes: Flat Panel Retrofit Kits, Channel Retrofit Kits, LED Channel Retrofit Kits, Troffer Retrofit Kits, and Commercial Recess Downlights.

## Commercial Recessed Downlight



### FEATURES AND BENEFITS

- Commercial Retrot Downlight
- Universal Voltage 120-277V
- UL for Safety
- Three Adjustable Lumen Output
- Three Adjustable CCT Options (3000K, 3500K, 4000K)
- High CRI
- Long Life
- Convenient and quick installation
- 0-10V Dimmable
- 25" Flexible Conduit
- Works in cold temperature applications
- 5 year warranty



RETROFIT KITS

Model No.	Type	Power Adjustable (W)	Input Voltage (V)	Lumens Adjustable (lm)	CRI	Beam Angle	Power Factor	Dia. X Height
VEKR4D/8T/10W-10V	4" Downlight	5/7/10	120-277	550 / 770 / 110	80	100°	0.9	5.71" x 3.70"
VEKR6D/8T/13W-10V	6" Downlight	6.5 / 9 / 13	120-277	790 / 1100 / 1560	80	100°	0.9	8.27" x 4.25"
VEKR8D/8T/17W-10V	8" Downlight	8.5 / 12 / 17	120-277	1030 / 1450 / 2040	80	100°	0.9	10.24" x 4.57"
VEKR9.5D/8T/27W-10V	9.5" Downlight	17 / 21 / 27	120-277	2070 / 2500 / 3240	80	100°	0.9	11.22" x 5.04"

Model No.	Type	Power Adjustable (W)	Input Voltage (V)	Lumens Adjustable (lm)	CRI	Beam Angle	Power Factor	Dia. X Height
VEKR4D/9T/14W-10V	4" Downlight	6 / 9 / 14	120-277	550 / 770 / 1100	90	90°	0.9	5.71" x 3.54"
VEKR6D/9T/21W-10V	6" Downlight	8.5 / 13.5 / 21	120-277	770 / 1100 / 1650	90	90°	0.9	8.27" x 4.10"
VEKR8D/9T/27W-10V	8" Downlight	12 / 19 / 27	120-277	1100 / 1650 / 2200	90	90°	0.9	10.24" x 4.41"
VEKR9.5/9T/40W-10V	9" Downlight	23 / 30.5 / 40	120-277	2050 / 2600 / 3000	90	100°	0.9	11.22" x 5.04"

## Emergency Inverter

### FEATURES AND BENEFITS

- Universal 120-347V AC, 50/60Hz Input
- Open Circuit Voltage 170VDC
- Charge/Power "ON" LED Indicator Light and Push-to-Test Switch for Code Compliance Testing
- Long Life, Maintenance Free, Lithium-Ion Battery
- Output Short and Overcurrent Protection: Electronic Limiting, with Normal Operation Resuming
- 90 Minute Minimum Emergency Operating Time Over Full Temperature Range
- Durable Steel Housing contains LED Driver and Battery
- 24 Hour Maximum Battery Recharge Time
- Major application includes commercial downlight and 0-10V fixtures
- 5 Year Warranty
- Meets UL924
- IC Rated

### DIMENSIONS

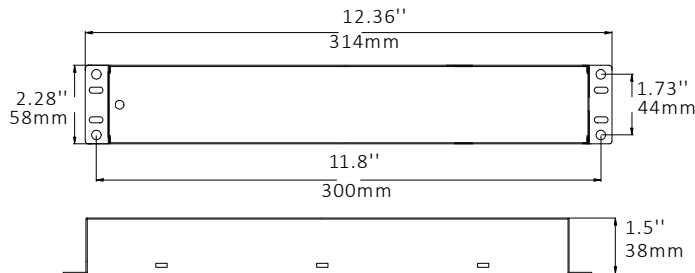

### WIRING DIAGRAM

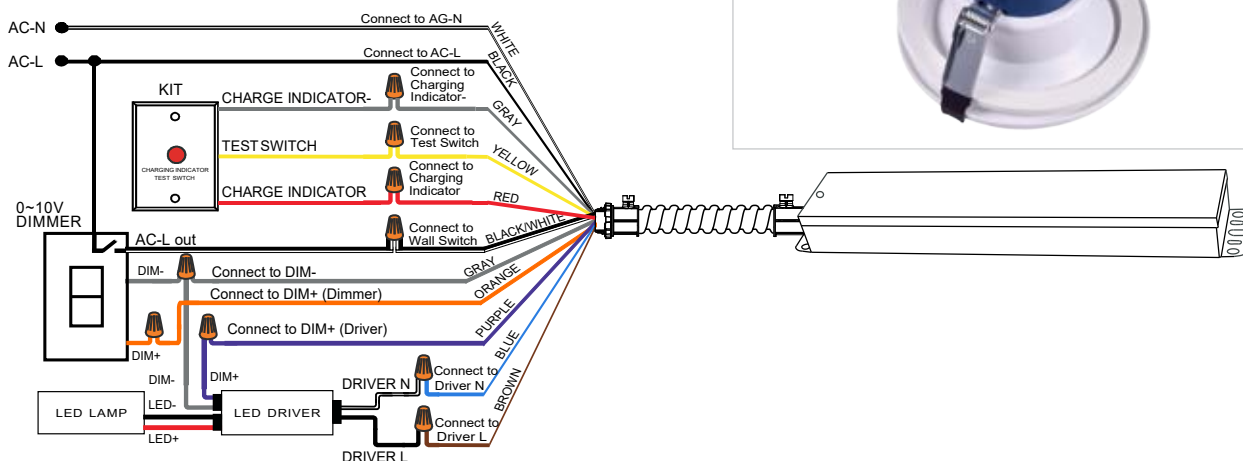

### VEMB15W-10V (D)



### VEMB8W-10V (S)

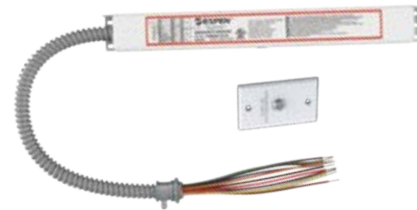

Model No.	Description
VEMB15W-10V (D)	Operates Espen Commercial Downlight or 0-10V Dimming Fixture up to 50W
VEMB8W-10V (S)	Operates Espen Commercial Downlight or 0-10V Dimming Fixture up to 80W

Compatible With Espen Commercial Downlight



RETROFIT KITS

# versaKIT™ versaLinear™

## LED Linear Module Retrofit Kits



### FEATURES AND BENEFITS

- Designed to Achieve High Lumen Output
- Each Kit Includes LED Modules Paired with an LED Driver
- LED Modules Feature Durable Aluminium Structures
- Magnetic Backing for Easier Installation
- Available with Frosted Diffuser Lens or No Diffuser Lens
- Kits Retrofit 2, 3 and 4 foot T5 and T8 Fixtures
- -20° F to 130° F Ambient Operating Temperature
- End-to-End Lighting with No Dark Spots
- 120 - 277V Input Voltage
- 80+ CRI
- 50,000 Hours Life
- Dimmable
- 5 Year Warranty

RETROFIT KITS



### 2 LAMP WIRING DIAGRAM

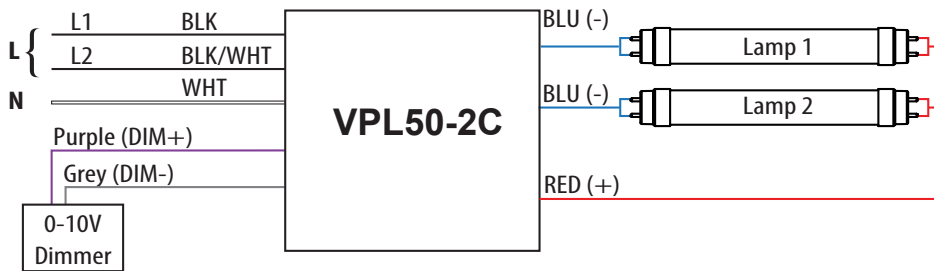

### 4 LAMP WIRING DIAGRAM

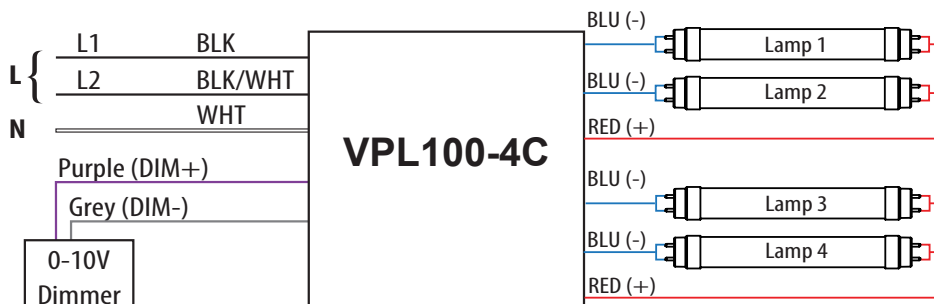

## LED Linear Module Retrofit Kits | 160lm/W System

### FEATURES AND BENEFITS

- Driver + Module kits, no lamp socket needed
- Magnet on the back for easy installation
- UL Class 2 Low Voltage System
- 4 Steps MacAdam Steps for Accurate Color
- Long life 50,000 hours
- 5 Years Warranty of Whole System
- Universal Input 120/277V
- 0-10V Dimming
- NSF 2 Complied with PC lens
- Aluminum backing for heatsink, independent to Fixtures

#### Content

- VLM2410F/8XX Linear LED Module
- Power Factor greater than 0.9
- THD less or equal to 20%

Model No.	Configura- tion	Mode	Driver Output Curret	System Lumen	System Wattage (W)	System Efficacy	CRI	Module	Driver
<b>VEBK2XF/8XX LED Linear Retrofit Kits</b>									
VEBK21F/8XX	1 lamp, 2ft	H	250mA	1675	11	153	>80	VLM2410F/8XX	VEL25050MVHDA-10V-P 025/035/050
VEBK22F/8XX	2 lamp, 2ft	L	250mA	1600	10.5	153	>80	VLM2410F/8XX	VEL25050MVHDA-10V-P 025/035/050
VEBK22F/8XX	2 lamp, 2ft	N	350mA	2325	15	155	>80	VLM2410F/8XX	VEL25050MVHDA-10V-P 025/035/050
VEBK22F/8XX	2 lamp, 2ft	H	500mA	3375	22	153	>80	VLM2410F/8XX	VEL25050MVHDA-10V-P 025/035/050
VEBK23F/8XX	2 lamp, 2ft	L	350mA	2250	14.5	155	>80	VLM2410F/8XX	VEL25050MVHDA-10V-P 025/035/050
VEBK23F/8XX	3 lamp, 2ft	N	500mA	3300	21.5	154	>80	VLM2410F/8XX	VEL25050MVHDA-10V-P 025/035/050
VEBK24F/8XX	4 lamp, 2ft	N	650mA	4375	28	156	>80	VLM2410F/8XX	VEL60130MVHDA-10V-P 065/095/130
VEBK24F/8XX	4 lamp, 2ft	H	950mA	6550	42	156	>80	VLM2410F/8XX	VEL60130MVHDA-10V-P 065/095/130
<b>VEBK3XF/8XX LED Linear Retrofit Kits</b>									
VEBK31F/8XX	1 lamp, 3ft	H	250mA	1700	11	155	>80	VLM3610F/8XX	VEL25050MVHDA-10V-P 025/035/050
VEBK32F/8XX	2 lamp, 3ft	L	250mA	1650	10.5	157	>80	VLM3610F/8XX	VEL25050MVHDA-10V-P 025/035/050
VEBK32F/8XX	2 lamp, 3ft	N	350mA	2350	15	157	>80	VLM3610F/8XX	VEL25050MVHDA-10V-P 025/035/050
VEBK32F/8XX	2 lamp, 3ft	H	500mA	3450	22	157	>80	VLM3610F/8XX	VEL25050MVHDA-10V-P 025/035/050
VEBK33F/8XX	2 lamp, 3ft	L	350mA	2300	14.5	157	>80	VLM3610F/8XX	VEL25050MVHDA-10V-P 025/035/050
VEBK33F/8XX	3 lamp, 3ft	N	500mA	3375	21.5	157	>80	VLM3610F/8XX	VEL25050MVHDA-10V-P 025/035/050
VEBK34F/8XX	4 lamp, 3ft	N	650mA	4400	28	157	>80	VLM3610F/8XX	VEL60130MVHDA-10V-P 065/095/130
VEBK34F/8XX	4 lamp, 3ft	H	950mA	6575	42	157	>80	VLM3610F/8XX	VEL60130MVHDA-10V-P 065/095/130

RETROFIT KITS

## LED Linear Module Retrofit Kits | 160lm/W System

RETROFIT KITS

Model No.	Configuration	Mode	Driver Output Current	System Lumen	System Wattage (W)	System Efficacy	CRI	Module	Driver
<b>VEBK4XF/8XX LED Linear Retrofit Kits</b>									
VEBK41F/8XX	1 lamp, 4ft	H	250mA	1700	11	155	>80	VLM4810F/8XX	VEL25050MVHDA-10V-P025/035/050
VEBK42F/8XX	2 lamp, 4ft	L	250mA	1700	10.5	162	>80	VLM4810F/8XX	VEL25050MVHDA-10V-P025/035/050
VEBK42F/8XX	2 lamp, 4ft	N	350mA	2425	15	162	>80	VLM4810F/8XX	VEL25050MVHDA-10V-P025/035/050
VEBK42F/8XX	2 lamp, 4ft	H	500mA	3575	22	162	>80	VLM4810F/8XX	VEL25050MVHDA-10V-P025/035/050
VEBK43F/8XX	2 lamp, 4ft	L	350mA	2350	14.5	163	>80	VLM4810F/8XX	VEL25050MVHDA-10V-P025/035/050
VEBK43F/8XX	3 lamp, 4ft	N	500mA	3400	21	163	>80	VLM4810F/8XX	VEL25050MVHDA-10V-P025/035/050
VEBK44F/8XX	4 lamp, 4ft	L	500mA	3350	21	160	>80	VLM4810F/8XX	VEL25050MVHDA-10V-P025/035/050
VEBK44F/8XX	4 lamp, 4ft	N	650mA	4475	28	160	>80	VLM4810F/8XX	VEL60130MVHDA-10V-P065/095/130
VEBK44F/8XX	4 lamp, 4ft	H	950mA	6700	42	160	>80	VLM4810F/8XX	VEL60130MVHDA-10V-P065/095/130
<b>VEBK4XF/HO/8XX LED Linear Retrofit Kits</b>									
VEBK41F/HO/8XX	1 lamp, 4ft	L	250mA	1675	10.5	160	>80	VLM4820F/HO/8XX	VEL25050MVHDA-10V-P025/035/050
VEBK41F/HO/8XX	1 lamp, 4ft	N	350mA	2425	15	161	>80	VLM4820F/HO/8XX	VEL25050MVHDA-10V-P025/035/050
VEBK41F/HO/8XX	1 lamp, 4ft	H	500mA	3375	21	161	>80	VLM4820F/HO/8XX	VEL25050MVHDA-10V-P025/035/050
VEBK42F/HO/8XX	2 lamp, 4ft	N	650mA	4500	28	161	>80	VLM4820F/HO/8XX	VEL60130MVHDA-10V-P065/095/130
VEBK42F/HO/8XX	2 lamp, 4ft	H	950mA	6400	40	160	>80	VLM4820F/HO/8XX	VEL60130MVHDA-10V-P065/095/130
VEBK43F/HO/8XX	3 lamp, 4ft	L	650mA	4450	27.5	162	>80	VLM4820F/HO/8XX	VEL60130MVHDA-10V-P065/095/130
VEBK43F/HO/8XX	3 lamp, 4ft	N	950mA	6650	41	162	>80	VLM4820F/HO/8XX	VEL60130MVHDA-10V-P065/095/130
VEBK43F/HO/8XX	3 lamp, 4ft	H	1300mA	9275	57	162	>80	VLM4820F/HO/8XX	VEL60130MVHDA-10V-P065/095/130
VEBK44F/HO/8XX	4 lamp, 4ft	L	950mA	6400	40	160	>80	VLM4820F/HO/8XX	VEL60130MVHDA-10V-P065/095/130
VEBK44F/HO/8XX	4 lamp, 4ft	N	1300mA	9000	56	160	>80	VLM4820F/HO/8XX	VEL60130MVHDA-10V-P065/095/130

# versaKIT™ versaLinear™

## LED Linear Module Retrofit Kits

Espen Model No.	DLC Model No.	Replaces	Diffuser Lens	No. of Modules Included	Driver Included	Driver Current	System Power (W)	System Lumens (lm)	System Efficacy (lm/W)
<b>2 Foot HE - High Efficiency</b>									
VEKM-L21C/8XX <sup>1,2</sup>	D546-1M-302C	1 x F17T8	No	1	VPL50	High	12	1500	125
						Normal	10	1250	125
VEKM-L21F/8XX <sup>1,2</sup>	D546-1M-302F	1 x F17T8	Yes	1	VPL50	High	12	1250	104
						Normal	10	1050	105
VEKM-L22C/8XX <sup>1,2</sup>	D546-2M-302C	2 x F17T8	No	2	VPL50	High	24	3000	125
						Normal	20	2500	125
VEKM-L22F/8XX <sup>1,2</sup>	D546-2M-302F	2 x F17T8	Yes	2	VPL50	High	24	2550	105
						Normal	20	2100	105
VEKM-L23C/8XX <sup>1,2</sup>	D547-3M-302C	3 x F17T8	No	3	VPL100	High	34	4300	126
						Normal	28	3600	129
VEKM-L23F/8XX <sup>1,2</sup>	D547-3M-302F	3 x F17T8	Yes	3	VPL100	High	34	3550	104
						Normal	28	3000	107
VEKM-L24C/8XX <sup>1,2</sup>	D547-4M-302C	4 x F17T8	No	4	VPL100	High	43	5600	130
						Normal	36	4700	131
VEKM-L24F/8XX <sup>1,2</sup>	D547-4M-302F	4 x F17T8	Yes	4	VPL100	High	43	4600	107
						Normal	36	3900	108
<b>3 Foot HE - High Efficiency</b>									
VEKM-L31C/8XX <sup>1,2</sup>	D546-1M-303C	1 x F25T8	No	1	VPL50	High	16	2100	131
						Normal	13	1750	135
VEKM-L31F/8XX <sup>1,2</sup>	D546-1M-303F	1 x F25T8	Yes	1	VPL50	High	16	1700	106
						Normal	13	1400	108
VEKM-L32C/8XX <sup>1,2</sup>	D546-2M-303C	2 x F25T8	No	2	VPL50	High	32	4250	133
						Normal	26	3500	135
VEKM-L32F/8XX <sup>1,2</sup>	D546-2M-303F	2 x F25T8	Yes	2	VPL50	High	32	3400	106
						Normal	26	2800	108
VEKM-L33C/8XX <sup>1,2</sup>	D547-3M-303C	3 x F25T8	No	3	VPL100	High	46	6100	133
						Normal	38	5000	132
VEKM-L33F/8XX <sup>1,2</sup>	D547-3M-303F	3 x F25T8	Yes	3	VPL100	High	46	5050	110
						Normal	38	4200	111
VEKM-L34C/8XX <sup>1,2</sup>	D547-4M-303C	4 x F25T8	No	4	VPL100	High	60	8000	133
						Normal	50	6500	130
VEKM-L34F/8XX <sup>1,2</sup>	D547-4M-303F	4 x F25T8	Yes	4	VPL100	High	60	6500	108
						Normal	50	5400	108

RETROFIT KITS

<sup>1</sup> XX = 30, 35, 40 or 50

30 = 3000K, 35 = 3500K, 40 = 4000K and 50 = 5000K (3000K may be subject to lead times and availability.)

<sup>2</sup> Not DLC listed. See 4 foot modules for DLC listed modules.

## LED Linear Module Retrofit Kits

RETROFIT KITS

Espen Model No.	DLC Model No.	Replaces	Diffuser Lens	Quantity of Modules Included	Driver Included	Drive Current	System Power (W)	System Lumens (lm)	System Efficacy (lm/W)
<b>4 Foot HE - High Efficiency</b>									
VEKM-L41C/8XX <sup>1,2</sup>	D546-1M-304C	1 x F32T8	No	1	VPL50	High	18	2300	128
						Normal	14	1850	132
VEKM-L41F/8XX <sup>1,2</sup>	D546-1M-304F	1 x F32T8	Yes	1	VPL50	High	18	1850	103
						Normal	14	1550	111
VEKM-L42C/8XX <sup>1,3</sup>	D546-2M-304C	2 x F32T8	No	2	VPL50	High	35	4600	131
						Normal	27	3700	137
VEKM-L42F/8XX <sup>1,3</sup>	D546-2M-304F	2 x F32T8	Yes	2	VPL50	High	35	3900	111
						Normal	27	3100	115
VEKM-L43C/8XX <sup>1,2</sup>	D547-3M-304C	3 x F32T8	No	3	VPL100	High	50	6900	138
						Normal	39	5550	142
VEKM-L43F/8XX <sup>1,2</sup>	D547-3M-304F	3 x F32T8	Yes	3	VPL100	High	50	5850	117
						Normal	39	4600	118
VEKM-L44C/8XX <sup>1,4</sup>	D547-4M-304C	4 x F32T8	No	4	VPL100	High	65	9250	142
						Normal	51	7400	145
VEKM-L44F/8XX <sup>1,4</sup>	D547-4M-304F	4 x F32T8	Yes	4	VPL100	High	65	7800	120
						Normal	51	6150	121
<b>4 Foot HO - High Output</b>									
VEKM-L41C/HO/8XX <sup>1,2</sup>	D546-1M-304C/HO	1 x 4'HO	No	1	VPL50	Normal	26	4000	150
VEKM-L41F/HO/8XX <sup>1,2</sup>	D546-1M-304F/HO	1 x 4'HO	Yes	1	VPL50	Normal	26	3400	130
VEKM-L42C/HO/8XX <sup>1,2</sup>	D547-2M-304C/HO	2 x 4'HO	No	2	VPL100	Normal	52	8000	150
VEKM-L42F/HO/8XX <sup>1,2</sup>	D547-2M-304F/HO	2 x 4'HO	Yes	2	VPL100	Normal	52	6800	130
<b>4 Foot VHO - Very High Output</b>									
VEKM-L41C/VHO/8XX <sup>1,2</sup>	D547-1M-304C/VHO	1 x 4'VHO	No	1	VPL100	Normal	52	8200	155
VEKM-L41F/VHO/8XX <sup>1,2</sup>	D547-1M-304F/VHO	1 x 4'VHO	Yes	1	VPL100	Normal	52	7000	135

<sup>1</sup> XX = 30, 35, 40 or 50

30 = 3000K, 35 = 3500K, 40 = 4000K and 50 = 5000K (3000K may be subject to lead times and availability.)

<sup>2</sup> Not DLC listed. See 4 foot modules for DLC listed modules.

<sup>3</sup> DLC listed.

<sup>4</sup> DLC pending.

**OPTIONS:** TAA (Trade Agreement Act Compliant)



### FEATURES AND BENEFITS

- Direct-Lit for better efficiency
- Utilizes Existing Housing to Reduce Installation Time and Cost of Labor
- Even Ambient Lighting
- -20° F to 130° F Ambient Operating Temperature
- Available in 2' x 2' and 2' x 4' Sizes
- Installation Brackets Included (*as seen on page 32*)
- Dimmable (0-10V Dimming)
- UL Recognized
- 5 Year Warranty



### Installation Brackets

for versaKIT Panel & versaKIT Troffer



RETROFIT KITS

Model No.	Retrofits	Power (W)	Lumens (lm)	Efficacy (lm/W)	Voltage (V)	CCT (K)	CRI	Life (L70) hours
<b>DLC Premium</b>								
VEKT-DP2X4	1 x 4 Troffer	18/22/25	2250/2750/3125	125	120 - 277	3500/4000/5000	80+	>100,000
VEKT-DP2X2	2 x 2 Troffer	18/22/25	2250/2750/3125	125	120 - 277	3500/4000/5000	80+	>100,000
VEKT-DP2X4	2 x 4 Troffer	23/30/36	2875/3750/4500	125	120 - 277	3500/4000/5000	80+	>100,000

**OPTIONS:**

- BAA (Buy American Act Compliant)
- TAA (Trade Agreement Act Compliant)

## LED Center Basket 3-Level Troffer Retrofit Kits



### FEATURES AND BENEFITS

- Central Basket Design
- Quick & Easy Installation
- 3-Level Selectable Current Setting
- Utilizes Existing Housing to Reduce Installation Time and Cost of Labor
- -20° F to 130° F Ambient Operating Temperature
- Center Diffuser Snaps in Place
- Reflective Surface for Uniform Distribution of Light
- Dimmable (0-10V Dimming), Dim-To-Off
- Dim-To-Off Optional



### Installation Brackets

versaKIT Troffer



### Dial Settings

3-Level Current Settings

VEKT2X2H	390mA	<input type="checkbox"/>
	470mA	<input type="checkbox"/>
	540mA	<input type="checkbox"/>
VEKT2X4L	600mA	<input type="checkbox"/>
	670mA	<input type="checkbox"/>
	750mA	<input type="checkbox"/>

RETROFIT KITS

Model No.	Application	Power (W)	Lumens (lm)	CCT (K)	Efficacy (lm/W)	Input Voltage (V)	CRI	Life (L70) hours
<b>Troffer Retrofit Kit</b>								
VEKT2X2-8T (20W/25W/30W)	2X2	20/25/30	2500/3125/3750	3500/4000/5000	125	120 - 277	80+	>100,000
VEKT2X4-8T (25W/30W/34W)	2X4	25/30/34	3125/3250/4250	3500/4000/5000	125	120 - 277	80+	>100,000

#### OPTIONS:

EM-10W (Emergency Battery Backup, 10 watts, ~1250lm)  
 OCC (Bi-Level Occupancy Sensor, Microwave)  
 BAA (Buy American Act Compliant)  
 TAA (Trade Agreement Act Compliant)

# versaKIT™ Channel



## LED Channel Retrofit Kits

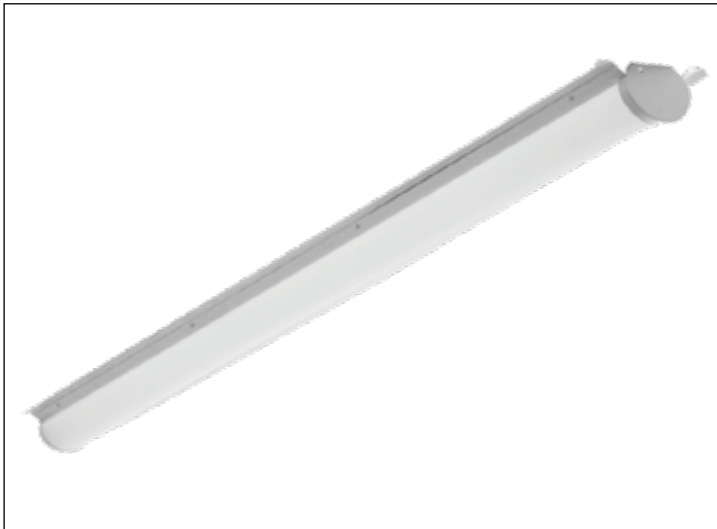

## FEATURES AND BENEFITS

- Utilizes Existing Housing to Reduce Installation Time and Cost of Labor
- Diffuser Lens Provides Uniform Ambient Lighting and Reduces Glare
- High Efficiency LED Module and LED Driver
- -20° F to 130° F Ambient Operating Temperature
- Dimmable (0-10V Dimming)
- Suitable for Damp Locations
- 5 Year Warranty



Model No.	Retrofits	Length (ft)	Power (W)	Lumens (lm)	Efficacy (lm/W)	Input Voltage (V)	CCT (K)	CRI	Life (L70) hours
<b>For T8 or Slim Line Applications</b>									
VEKL4F/23-830	4' Channel	4	23	3000	130	120 - 277	3000	80+	>100,000
VEKL4F/23-835	4' Channel	4	23	3000	130	120 - 277	3500	80+	>100,000
VEKL4F/23-840	4' Channel	4	23	3000	130	120 - 277	4000	80+	>100,000
VEKL4F/23-850	4' Channel	4	23	3000	130	120 - 277	5000	80+	>100,000
VEKL8F/46-830	8' Channel	8	46	5980	130	120 - 277	3000	80+	>100,000
VEKL8F/46-835	8' Channel	8	46	5980	130	120 - 277	3500	80+	>100,000
VEKL8F/46-840	8' Channel	8	46	5980	130	120 - 277	4000	80+	>100,000
VEKL8F/46-850	8' Channel	8	46	5980	130	120 - 277	5000	80+	>100,000
<b>For HO or VHO Line Applications</b>									
VEKL4F/40-830	4' Channel	4	40	5240	131	120 - 277	3000	80+	>100,000
VEKL4F/40-835	4' Channel	4	40	5240	131	120 - 277	3500	80+	>100,000
VEKL4F/40-840	4' Channel	4	40	5240	131	120 - 277	4000	80+	>100,000
VEKL4F/40-850	4' Channel	4	40	5240	131	120 - 277	5000	80+	>100,000
VEKL8F/65-840	8' Channel	8	65	8500	131	120 - 277	4000	80+	>100,000
VEKL8F/65-850	8' Channel	8	65	8500	131	120 - 277	5000	80+	>100,000
VEKL8F/90-830	8' Channel	8	90	11440	127	120 - 277	3000	80+	>100,000
VEKL8F/90-835	8' Channel	8	90	11440	127	120 - 277	3500	80+	>100,000
VEKL8F/90-840	8' Channel	8	90	11440	127	120 - 277	4000	80+	>100,000

### OPTIONS:

- EM-10W (Emergency Battery Backup, 10 watts, ~1250lm)
- OCC (Bi-Level Occupancy Sensor, Microwave)
- BAA (Buy American Act Compliant)
- TAA (Trade Agreement Act Compliant)



# versaKIT™ Strip

## LED Strip Retrofit Kits



### FEATURES AND BENEFITS

- Converts 8 Foot T12 or T8 Fluorescent Strip Lights to the Latest 4 Foot LED Technology
- Holds Two Rows of Two LED T8 Lamps
- Compatible with Type A, B, & C Lamps for Rebate Programs
- Can Reduce Energy Costs Up to 50% While Still Maintaining Existing Light Levels
- 5 Year Warranty



RETROFIT KITS

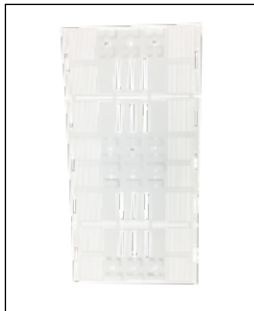

[1] Universal Socket Plate

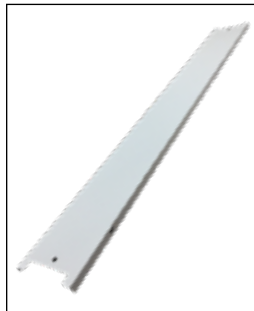

[2] Ballast Cover (white)



[8] Screws



[4] Quarter Turn Fasteners



[8] Sockets

Model No.	Socket Type	Case Qty.
<b>8 Foot Channel Retrofit Kits for Linear LED Lamps</b>		
RXS8-432-USP-WH/10 PACK	Shunted	10
RXS8(NS)-432-USP-WH/10 PACK	Non-Shunted	10

# Sentinel®

## Emergency Solutions

The Sentinel family of LED emergency ballasts, inverters, and drivers provide a complete set of emergency back up solutions for Types A, B, and C LED retrofit products. When AC power fails, Sentinel LED battery back up products switch to emergency mode and keep LED retrofit products illuminated at a reduced lumen output for a minimum of 90 minutes. The Sentinel emergency ballasts are for Type A lamps. The Sentinel emergency inverters are for Type B lamps. While the Sentinel emergency drivers are for Type C lamps, retrofit kits, and fixtures. Sentinel LED emergency back ups are suitable for use in new fixtures or retrofit applications, and most models include: LED charging indicator light, single-pole test switch, and installation hardware.



### Standalone Emergency Back-Up Kits

Suitable for any applications  
Standalone operation



### Emergency Inverters

Suitable for LED Type B or A+B lamps, retrofit kits and LED fixtures, esp. integrated fixtures  
Power up the whole fixture



### Emergency Ballasts

Suitable for LED Type A or A+B lamps with fluorescent ballasts  
Directly power the lamps

## Standalone Emergency Back-Up Kits

### Constant Wattage LED FEATURES AND BENEFITS

- Constant Wattage & Light Output
- High Efficacy LED Module
- Does not Affect Existing Lighting Fixture / Luminaire
- UL Listed

### DIMENSIONS

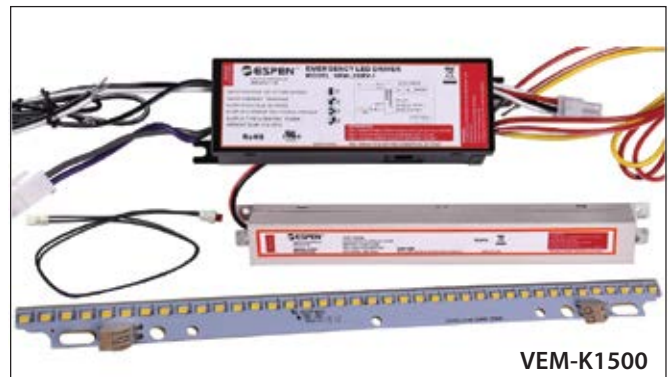
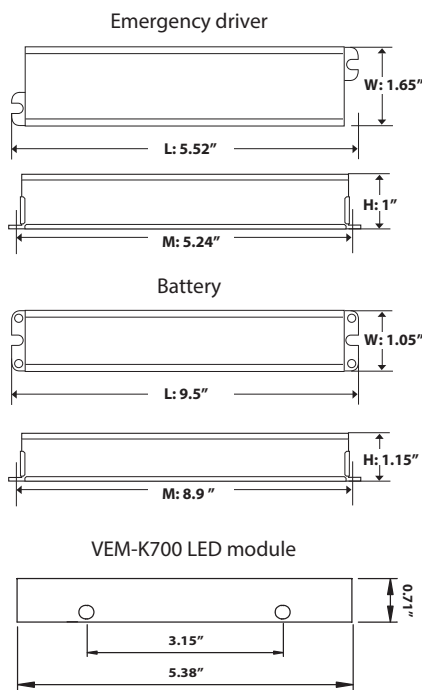

EMERGENCY SOLUTIONS

### WIRING DIAGRAM

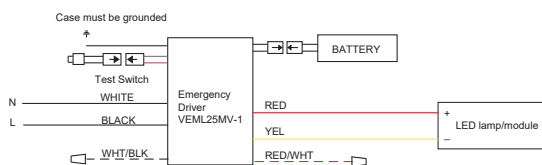

Model #	Dip Switch Setting	Emergency Mode Output Power	Emergency Mode Output Voltage	Emergency Mode Output Current	Battery Charging Current
VEM-K1000		8W	12-50V	416-100mA	60mA
VEM-K1500		10W	12-50V	830-200mA	100mA

Model No.	Lumens (90min)	Wattage	Module Information
VEM-K1000	1000lm	8W	VLM0605L/850 8W, 5000K, CRI80
VEM-K1500	1500lm	10W	VLM1207L/850 10W, 5000K, CRI80

## Emergency Inverters

### FEATURES AND BENEFITS

- Universal 120-347V AC, 50/60Hz Input
- Open Circuit Voltage 170VDC
- Charge/Power "ON" LED Indicator Light and Push-to-Test Switch for Code Compliance Testing
- Long Life, Maintenance Free, Lithium-Ion Battery
- Output Short and Overcurrent Protection: Electronic Limiting, with Normal Operation Resuming
- 90 Minute Minimum Emergency Operating Time Over Full Temperature Range
- Durable Steel Housing contains LED Driver and Battery
- 24 Hour Maximum Battery Recharge Time
- Major application includes commercial downlight and 0-10V fixtures and 0-10V fixtures
- 5 Year Warranty
- Meets UL924
- IC Rated

### DIMENSIONS

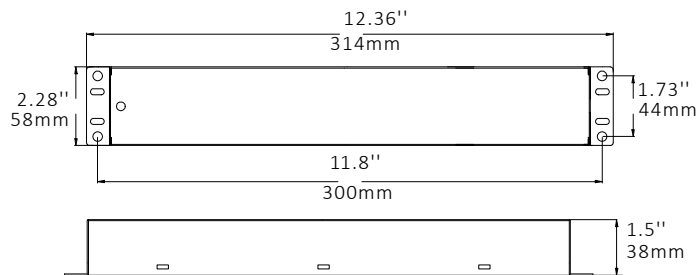

### WIRING DIAGRAM

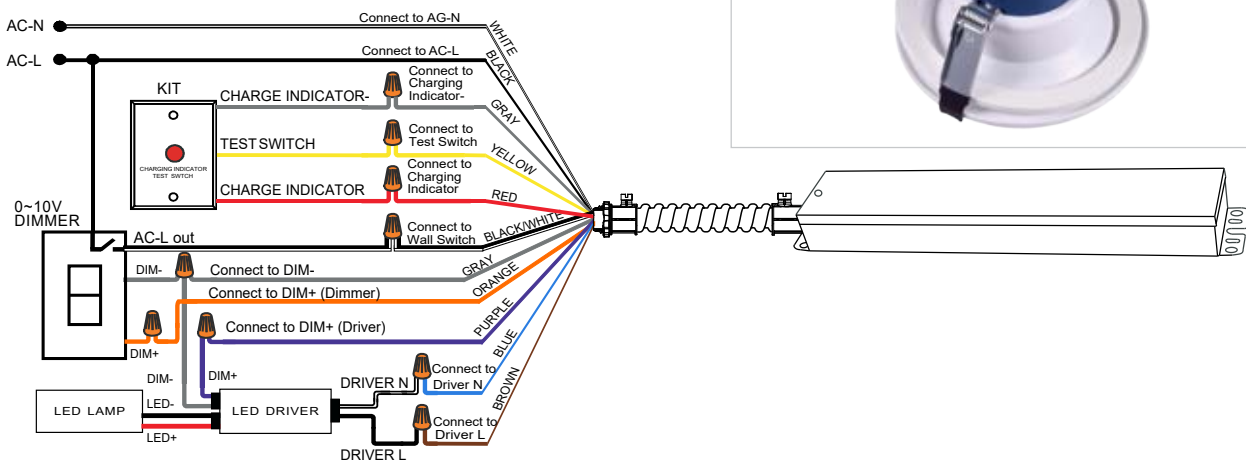

### VEMB15W-10V (D)



### VEMB8W-10V (S)

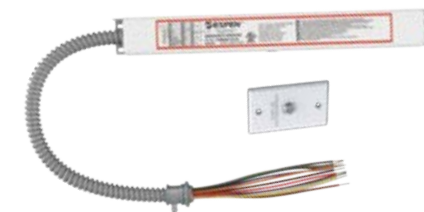

Model No.	Description
VEMB15W-10V (D)	Operates Espen Commercial Downlight or 0-10V Dimming Fixture up to 50W
VEMB8W-10V (S)	Operates Espen Commercial Downlight or 0-10V Dimming Fixture up to 80W

### Compatible With Espen Commercial Downlight



EMERGENCY SOLUTIONS

# Sentinel®



## Type C Emergency LED Driver

### FEATURES AND BENEFITS



#### VEM500DV-L - Emergency Ballast

- Dual Input Voltage (120/277V)
- Maintenance Free, Long Life
- High Temperature Ni-Cad Battery
- Durable, Heavy-Duty Steel Housing
- 1-lamp: 500 lumens
- 5 Year Limited Warranty



#### VEM800DV-L - Emergency Ballast

- Dual Input Voltage (120/277V)
- Maintenance Free, Long Life
- High Temperature Ni-Cad Battery
- Durable, Heavy-Duty Steel Housing
- 1-lamp: 800 lumens
- Slim Design
- 5 Year Limited Warranty



#### VEM1300DV-L - Emergency Ballast

- Dual Input Voltage (120/277V)
- Maintenance Free, Long Life
- High Temperature Ni-Cad Battery
- Durable, Heavy-Duty Steel Housing
- 1-lamp: 1,300 lumens | 2-lamp: 1,300 lumens
- Slim Design
- 5 Year Limited Warranty



EMERGENCY SOLUTIONS

Model No.	Type	Lumens	Voltage (V)	Operation Hours	Case
VEM500DV-L	Emergency Ballast	500	120/277	90 mins	Regular
VEM800DV-L	Emergency Ballast	800	120/277	90 mins	Slim
VEM1300DV-L	Emergency Ballast	1300	120/277	90 mins	Slim

\* Operating hours, 90min at full lumen output.

\*\* EM ballast will continue to produce light after 90min, but lumen output will reduce over time.

# Step-Down Transformer

## Non-Isolated Autotransformer



### PRODUCT FEATURES

- Non-isolated autotransformer
- UL listed
- Thermally protected (auto reset)
- Max case temperature 105C
- Sound rated A
- 5 year limited warranty
- Designed for lighting applications
  - LED
  - Electronic ballasts
  - HID
- Low profile cases

### APPLICATION NOTES

- Supply current frequency 60Hz
- Do not use on ungrounded systems

Model No.	Voltage (V)	Input Current Max	Power at Max Load	Output Voltage	Max Load (VA)	Case	Wiring Diagram
VETR480/277-110VA	480/347	0.229/0.317	125W	277/240	110	B	WD-1
VETR480/277-375VA	480/347	0.781	410W	277/200	375/270	C	WD-2

\* Inquire for availability.

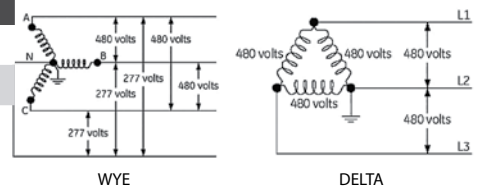

### PHYSICAL PARAMETERS

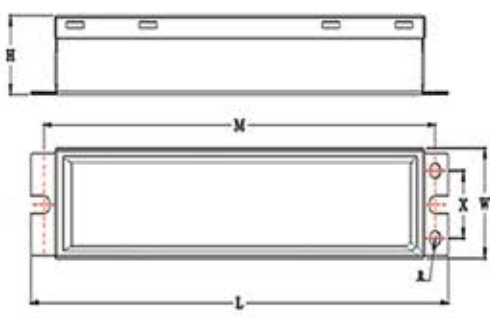

CASE DIMENSIONS IN INCHES			
Case	A	B	C
L	7.20	9.49	11.70
M	6.61	8.90	11.14
W	1.73	1.73	1.73
X	1.06	1.06	1.06
H	1.30	1.30	1.30
R	1.30	1.30	1.30
Lead Lengths	15"/16AWG	14"/16AWG	14"/16AWG

### Why do we use VA instead of Watts when setting Step-Down Transformer loads?

The power in watts is the real power drawn by the equipment. Volt-Amps (VA) are called the "apparent power" and is the product of the voltage applied to the equipment times the current drawn by the equipment.

\*Use one of these formulas to determine the missing quantity:  
 Watts = VA \*Power factor or VA = Watts / Power Factor

### WIRING DIAGRAMS

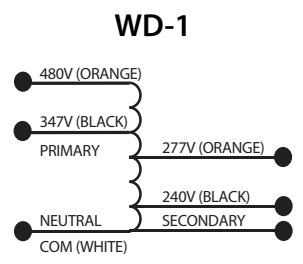

VETR480/277-60VA & VETR480/277-110VA  
Cap all unused wires

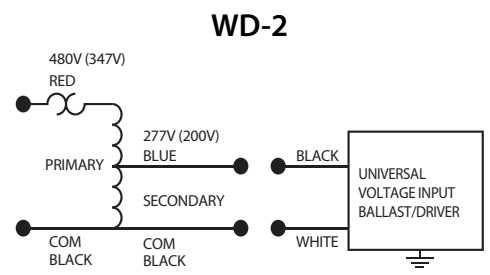

VETR480/277-250VA & VETR480/277-375VA

# Controls

## High Bay Sensors

### OCCUPANCY SENSOR | 360° HIGH BAY PASSIVE INFRARED (PIR) FIXTURE MOUNT



### SPECIFICATIONS

Voltage:	120/277VAC, 60 Hz
Load Requirement:	800VA @120VAC* 1200VA @277VAC* * Fluorescent Ballasts No Min
Load Horsepower:	1/6HP
Time Delay Adjustment:	Fixed 15 seconds to 30 minutes
Operating Temperature:	32° to 131° F (0° to 55° C)
Humidity Range:	0% to 90% RH, non-condensing
Coverage Range:	High Bay mounting heights up to 30 ft mounting/360° field
Terminal Line:	Black - Hot, White - Neutral, Red - Load

The FMH-6A-MV (UM) Occupancy Sensor is designed to mount directly onto a luminaire and is ideal for high mounted areas such as warehouses, manufacturing facilities, and other high ceiling applications.

Other mounting options include: Ceiling mount, J-Box Mount

### OPERATION

The sensor detects changes in the infrared energy given off by occupants as they move within the field-of-view. When occupancy is detected, a self-contained relay switches the connected lighting load on. The sensor is line powered and can switch line voltage. An internal timer, factory set at 15 seconds, keeps the lights on during brief periods of inactivity.

### OPERATIONAL MODES

Auto ON, Auto OFF

### COVERAGE AREA

Best choice for 15 to 30 ft mounting heights. 15 to 20 ft radial coverage overlaps area lit by a typical high bay fixture (refer to Fig. A)

### WIRING DIAGRAM

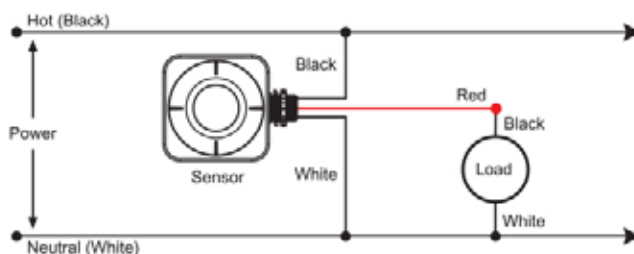

### TYPICAL APPLICATIONS

- Warehouses
- Gymnasiums
- Manufacturing Facilities
- Industrial Facilities

### FEATURES

- PIR Occupancy Detection
- Self Contained Relay, no Power Pack needed
- Adjustable Time Delay: 15 sec - 30 mins
- Frequency: 50/60Hz
- UL, cUL
- CA Title 24 Compliant
- 5 Year Warranty

# Controls

## 0-10V Dimmers



VED1-10V	
Application	Single-Pole 0-10V dimmer
Color	White
VED3-10V	
Application	3-Way 0-10V dimmer
Color	White

## FEATURES AND BENEFITS

- UL and cUL Listed for Safety
- Smooth Slide Dimming Control
- Full-range Dimming
- Min. and Max. Dimming Range Adjustable
- Operating Temperature: 32° to 104°
- Five Year Warranty

## PRODUCT SPECIFICATION

### GENERAL CHARACTERISTICS

Switch Type VED1-10V	Single-Pole
Switch	Standard ON/OFF
Dimmer	Slide
Voltage	120-277VAC, 50-60Hz
Load Rating	720VA
Load Type	Electronic 0-10VDC Fluorescent Ballast and 0-10VDC LED Power Supply

### WIRING DIAGRAM: VED1-10V

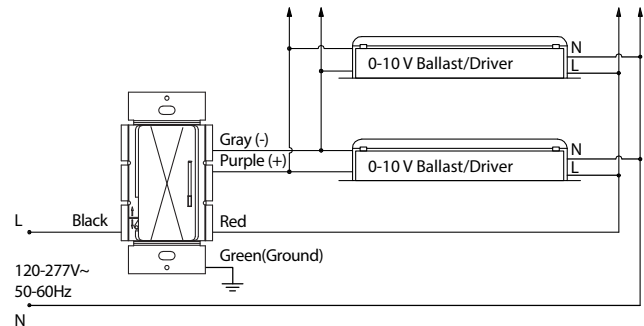

### GENERAL CHARACTERISTICS

Switch Type VED3-10V	3-WAY 0-10V Dimmer
Switch	Standard ON/OFF
Dimmer	Slide
Voltage	120-277VAC, 50-60Hz
Load Rating	720VA
Load Type	Electronic 0-10VDC Fluorescent Ballast and 0-10VDC LED Power Supply

### WIRING DIAGRAM: VED3-10V

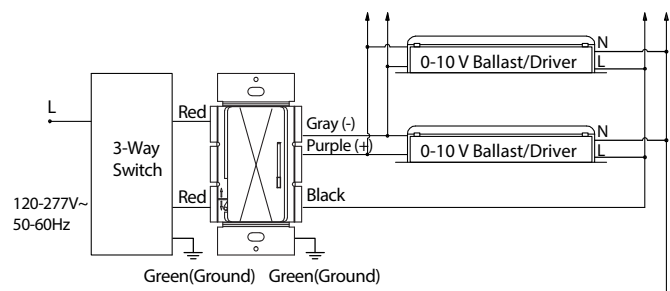

## DIMENSION LAYOUT

### DIMENSIONS

Length (inches)	4.14
Width (inches)	2.13
Depth (inches)	1.66

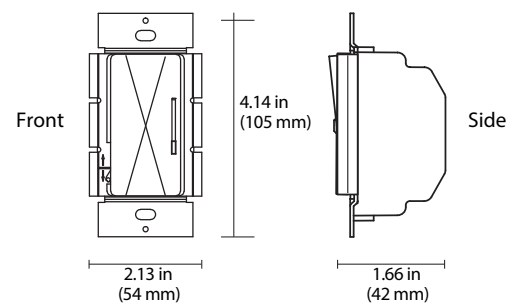

## BI-LEVEL DAYLIGHT HARVEST SENSORS

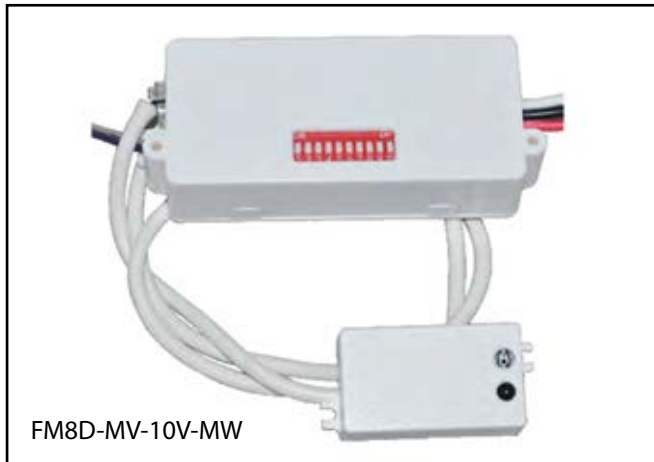

### DESCRIPTION

Our FM8D-MV-10V-MW is a moving object sensor that can detect a range of 360°. Fully adjustable high and low dimmed light level. Designed for LED fixtures rated for extreme temperatures and up to 2000,000 on/off cycles. This products stable working state adopts a microwave sensor (high-frequency output<0.2mW) it is safe and performs better than an infrared sensor.

Daylight Harvest Function: This function inside the motion sensor to achieve tri-level control, for some areas which require a light change notice before switch-off. The sensor offers 3 levels of light: 100%—>dimmed light (natural light is insufficient) off; and 2 periods of selectable waiting time: motion hold-time and stand-by period; Selectable daylight threshold and freedom of detection area.

### FEATURES AND BENEFITS

- Constant light output
- Provides line voltage On/Off switching and 0-10VDC dimming control
- Works with electronic ballasts or LED drivers
- High and low modes fully adjustable from 0-10VDC
- Time delay from 10 seconds to 60 minutes
- Optional cut off delay
- Adjustable ramp up and fade down times
- High inrush stability zero crossing circuitry for reliable, long-life operation catching relay is durable for all load.
- UL773A and FCC

### TECHNICAL SPECIFICATIONS

- Input Voltage: 120-277Vac, 60Hz
- Maximum Load  
Resistive/Tungsten  
600VA@120V  
Electronic Ballast/LED driver  
800VA@120V/1200VA@277V
- Dimming Control Output: 0-10V  
25mA Sink Current
- Detection Radius/Range: Max. 26ft 360 degree
- Mounting Height: Max. 40ft
- Operation Condition: -40 degree F to 130 degree F

### CASE DIMENSION:

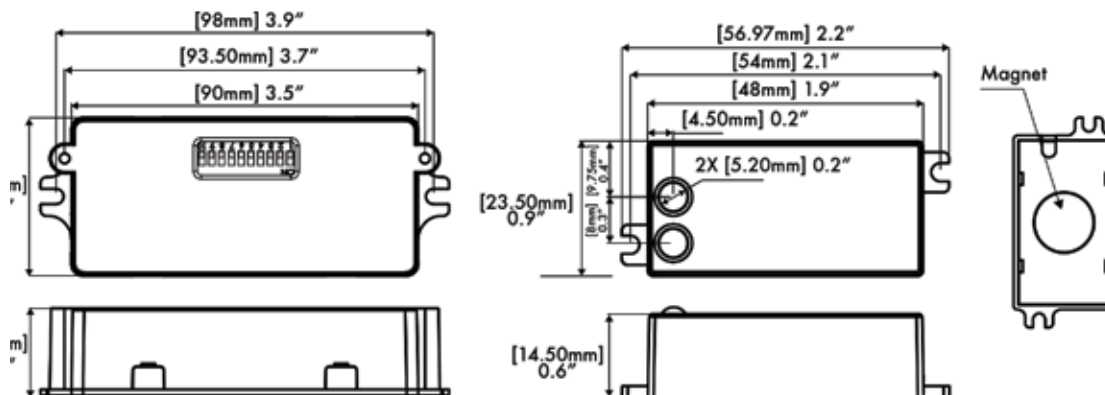

# Controls

## BI-LEVEL DAYLIGHT HARVEST SENSORS

### DAYLIGHT HARVEST FUNCTION

The light will not switch on when natural light is sufficient, even there is motion detected.

The light switches on automatically with presence when natural light is insufficient.

The light turns on at full or dims to maintain the lux level. The light output regulates according to the level of natural light available.

The light dims to stand-by period after hold-time and stays on selected minimum dimming level.

The light switches off completely after the stand-by period.

### COVERAGE

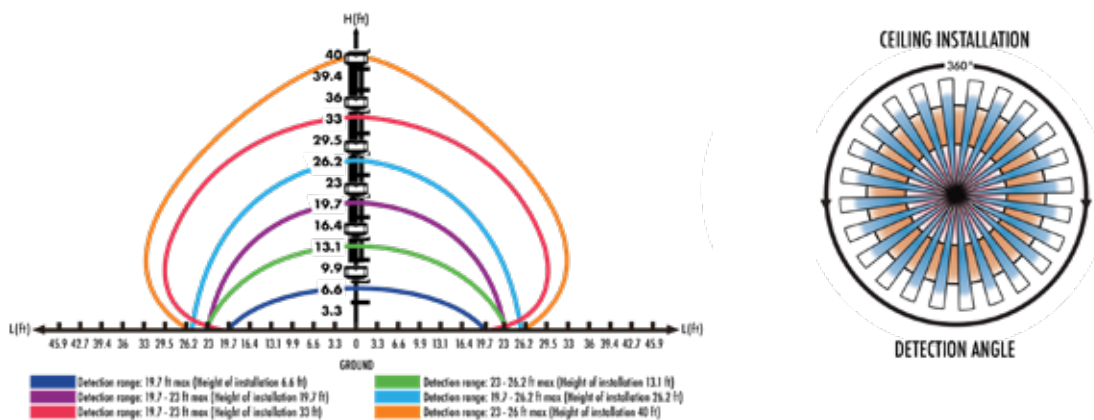

### WIRING DIAGRAM

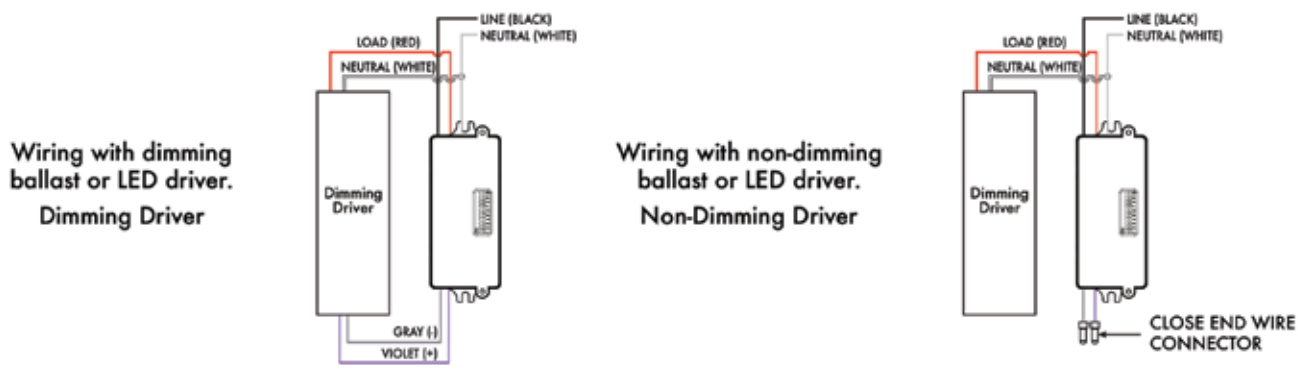

RF/ 0-10V Adaptor  
Dual Channel for Dim & CCT

RF LED Lamps  
Dimmable Type B and CCT Tuning

Desktop Charger

versaDim™ RF

RF Retrofit Kit  
Dim and/or CCT Tuning

RF Remote  
Dual Channel for Dim & CCT

Wireless Wall Mount Charger  
Universal Input, 120-277V

## FEATURES AND BENEFITS

- Dual Channel for Dimming and CCT Tuning
- Wall Mount Wireless Charger
- Adapter to Convert Current Fixtures to RF
- Dual Channel Drivers for New Fixtures
- Dimmable Type B Lamps
- Universal 120-277V Input
- Capable of Zoning Control
- Emergency Switch
- Highly Secure System
- UL Certified

## DESCRIPTION

Complete system of wirelessly controlled linear LED retrofit products, using a handheld remote control. Dims lights, changes color temperature, or turns lights on/off. Use with ballast bypass (Type B) TLEDs, an LED troffer retrofit kit, or 0-10V fixtures.

Avoids costly commissioning of most wireless systems dual channel for dimming. Wall mount wireless charger. Adapter to convert existing fixtures to RF control. Dual channel drivers for new fixtures. Zoning control capability.

# Controls

## versaDim RF Control System Charger & Remote



### FEATURES AND BENEFITS

- Dual Channel for Dimming
- Wall mount wireless charger
- Adapter to convert current fixtures to RF
- Dual channel drivers for new fixtures
- Dimmable Type B lamps
- Universal 120-277V input
- Capable of zoning control
- Emergency switch
- Highly secure system
- UL certified

### OPERATION

versaDim RF control system charger VC720MV wireless charges versaDim RF remote and relay on/off control to LED power supply.

### ELECTRICAL RATING

Model No.	Electrical Data		
versaDim Charger & Remote			
	Input Voltage (V)	Input Current Max	Charging (Output)
VC720MV versaDim RF Charger	120Vac 50/60Hz 240Vac 50/60Hz	0.2A	5Vdc 1A
	Wireless Charging Voltage	Wireless Charging Current	Wireless Charging Voltage
VRF-DR versaDim RF remote	5vdc	60mA	
VRF-DM-SET Desktop Charger	2W	60mA	5Vdc

### WIRING DIAGRAM

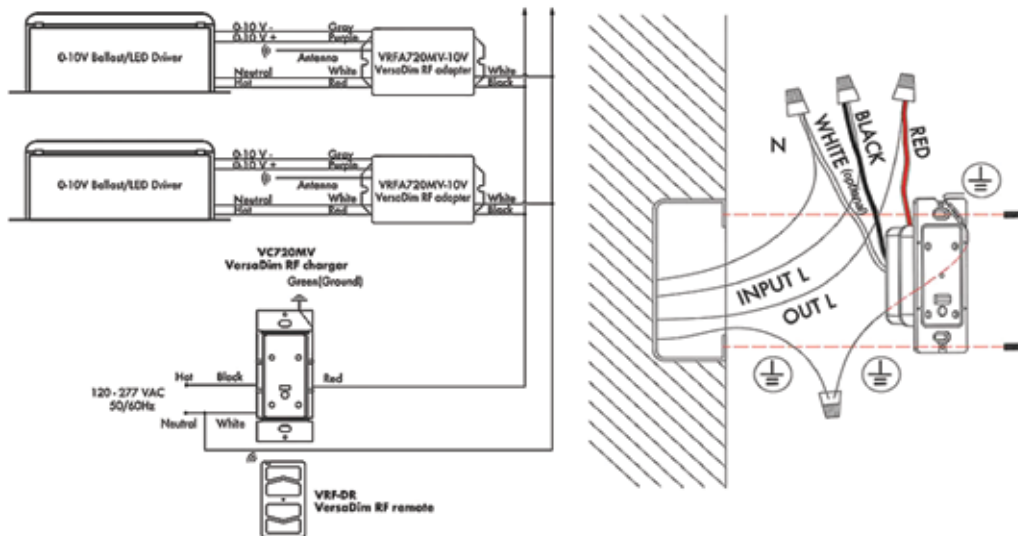

# Controls

## versaDim RF ADAPTER



## FEATURES AND BENEFITS

- Dual Channel for Dimming
- Wall mount wireless charger
- Adapter to convert current fixtures to RF
- Dual channel drivers for new fixtures
- Dimmable Type B lamps
- Universal 120-277V input
- Capable of zoning control
- Emergency switch
- Highly secure system
- UL certified

## OPERATION

versaDim RF control system charger VC720MV wireless charges versaDim RF remote and relay on/off control to LED power supply.

## ELECTRICAL RATING

Model No.	Input Voltage (V)	Input Current Max	Input Wattage Max	Charging (Output)
versaDim RF Adapter				
VRFA720MV-10V versaDim RF adapter	120V AC, 50-60Hz 277 AC, 50-60Hz Electronic ballast LED driver	6A 3A Electronic ballast LED driver	0.4W Electronic ballast LED driver	5VDC, 60mA

## WIRING DIAGRAM

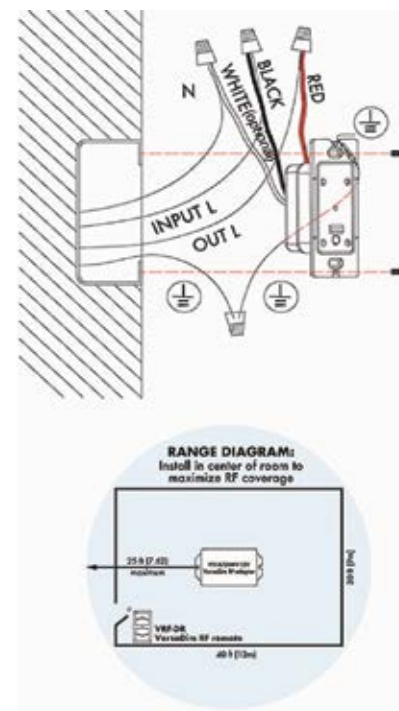
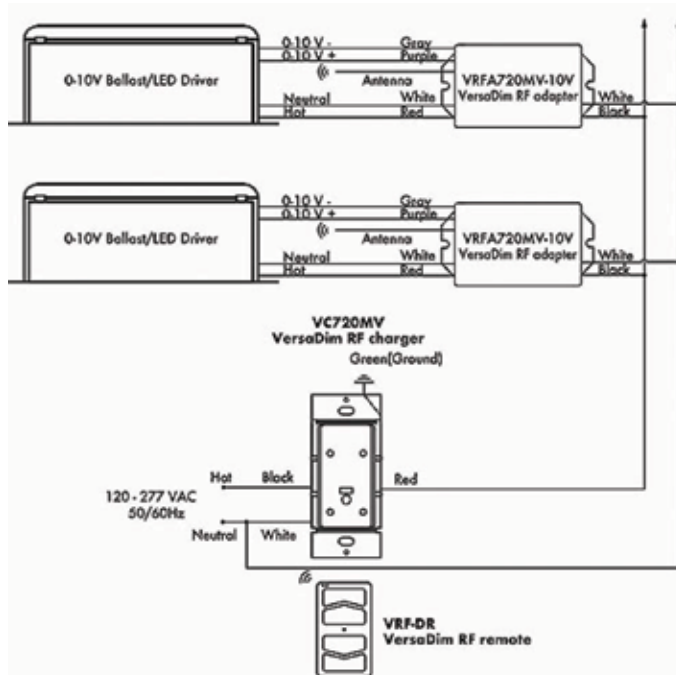

# Controls

versaDim RF | Type B



## FEATURES AND BENEFITS

- versaDim RF Remote Control
- Internal Driver
- Smooth, Consistent Light
- UL for Safety
- No UV, No Mercury
- Long Life
- High CRI
- Instant on, no delay or warm up time
- Convenient and quick installation
- Input from Both Ends
- Utilizes shunted or unshunted G13 sockets
- Works in cold temperature applications
- High performance plastic series
- 5 Year Warranty
- Superior Wide View Angle



Model No.	Length	Base Type	Lamp Wattage	Input Voltage	CCT	Initial Lumens	CRI	Beam Angle	LPW	Power Factor	THD
<b>Flex DE T8 Lamp</b>											
L24T8/830/9P-ID DE RF	24	G13	9	120-277	3000K	1100	82	325	122	0.9	<20%
L24T8/835/9P-ID DE RF	24	G13	9	120-277	3500K	1100	82	325	122	0.9	<20%
L24T8/840/9P-ID DE RF	24	G13	9	120-277	4000K	1100	82	325	122	0.9	<20%
L24T8/850/9P-ID DE RF	24	G13	9	120-277	5000K	1100	82	325	122	0.9	<20%
L36T8/830/12P-ID DE RF	36	G13	12	120-277	3000K	1400	82	325	117	0.9	<20%
L36T8/835/12P-ID DE RF	36	G13	12	120-277	3500K	1400	82	325	117	0.9	<20%
L36T8/840/12P-ID DE RF	36	G13	12	120-277	4000K	1400	82	325	117	0.9	<20%
L36T8/850/12P-ID DE RF	36	G13	12	120-277	5000K	1400	82	325	117	0.9	<20%
L48T8/830/12P-ID DE RF	48	G13	12	120-277	3000K	1800	82	325	150	0.9	<20%
L48T8/835/12P-ID DE RF	48	G13	12	120-277	3500K	1800	82	325	150	0.9	<20%
L48T8/840/12P-ID DE RF	48	G13	12	120-277	4000K	1800	82	325	150	0.9	<20%
L48T8/850/12P-ID DE RF	48	G13	12	120-277	5000K	1800	82	325	150	0.9	<20%

## Ordering Information

EXAMPLE: L48T8/840/12P-ID DE RF

<b>L</b>	<b>48</b>	<b>T8</b>	<b>8</b>	<b>40</b>	<b>12 P</b>	-	<b>ID</b>	<b>DE</b>	<b>RF</b>
Manufacturer's Code	Normal Length 48 = 48"	Lamp Shape T8 = T8	CRI 8 => 80	CCT 50 = 5000K 40 = 4000K 35 = 3500K	Wattage 12P-12W		Internal Driver	Double End Input	versaDim RF Control System

CONTROLS

# Controls

versaDim RF I Type B LED

## WIRING DIAGRAM

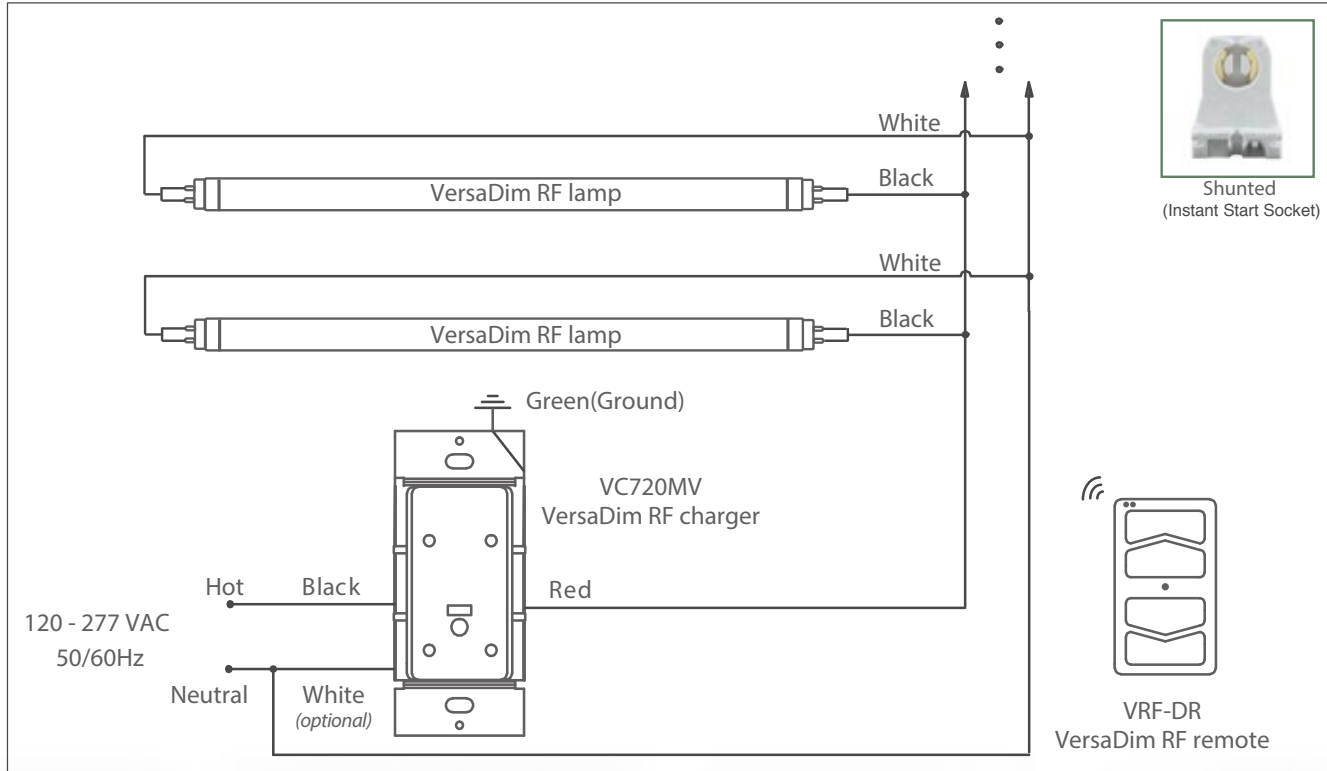

# Controls

versaDim RF Type B 5CCT



## FEATURES AND BENEFITS

- versaDim RF 2.4GHz Remote Control System compatible
- Easy Pairing and controlling with versaDim RF remote
- 5-CCT Selectable with versaDim RF remote
- Max. 25ft control distance from versaDim RF remote or RF lamp
- Internal Driver
- UL for Safety
- No UV, No Mercury
- Long Life
- High CRI
- Instant on, no delay or warm up time
- Convenient and quick installation
- Utilizes shunted or unshunted G21 sockets
- NSF 2 rated with high performance nano plastic series
- Works in cold temperature applications
- 5 Year Warranty



## WIRING DIAGRAM

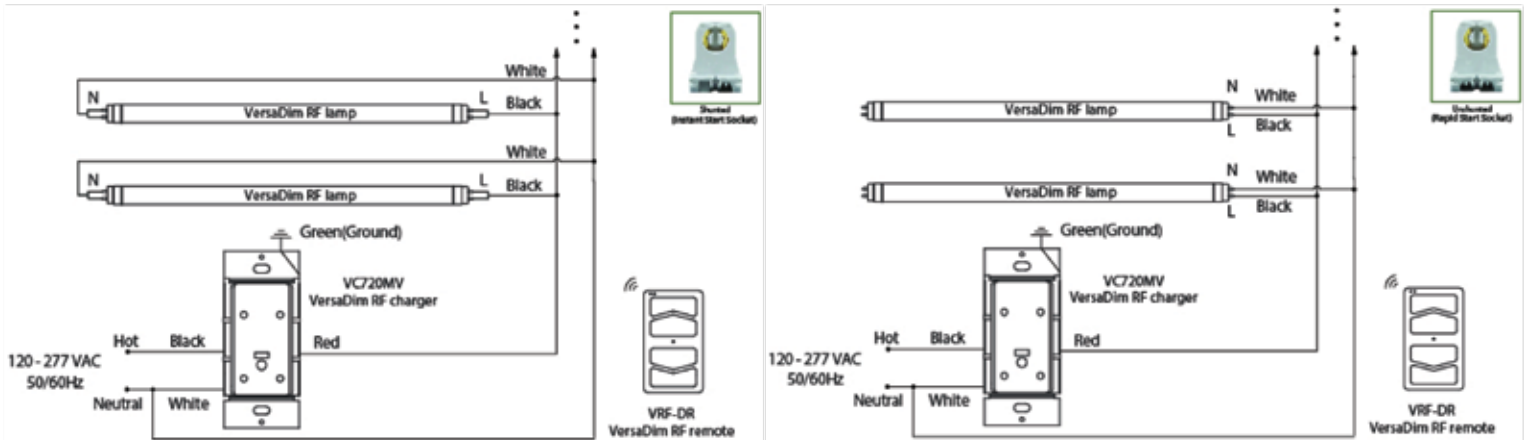

Model No.	Length	Base Type	Lamp Wattage (W)	Input Voltage (V)	5-CCT Selectable via versaDim Remote	Initial Lumens	CRI	Beam Angle	LPW	Power Factor	THD	Life (h)
<b>Troffer Retrofit Kit</b>												
L48T8/8F/12P-ID DE RF	48	G13	12	120-277	27K/30K/35K/40K/50K	1800	80	225	142	0.9	<20%	50000
L36T8/8F/12P-ID DE RF	36	G13	12	120-277	27K/30K/35K/40K/50K	1450	80	225	127	0.9	<20%	50000
L24T8/8F/9P-ID DE RF	24	G13	9	120-277	27K/30K/35K/40K/50K	1150	80	225	121	0.9	<20%	50000

CONTROLS



the **Power** to Create Better Light™



#### HEADQUARTERS

Espen Technology Inc.  
12257 Florence Ave  
Santa Fe Springs, CA 90670 USA

#### WAREHOUSE

Espen Technology Inc.  
1350 Brookville Way, Suite F  
Indianapolis, IN 46239 USA

#### SALES/CUSTOMER SERVICE

Toll Free Tel: (866) 933-7736  
Toll Free Fax: (888) 503-7736  
Tel: (562) 529-2938  
Fax: (562) 529-2978

#### CONNECT:

[facebook.com/espentech](https://facebook.com/espentech)  
[twitter.com/espentech](https://twitter.com/espentech)  
[youtube.com/espentechnology](https://youtube.com/espentechnology)  
[instagram.com/espentechnology](https://instagram.com/espentechnology)  
[linkedin.com/company/espen-technology](https://linkedin.com/company/espen-technology)

#### EMAIL

[info@espentech.com](mailto:info@espentech.com)

ESLED0622

© 2022 Espen Technology, Inc.  
All rights reserved. Reproduction in whole or part is prohibited without the prior written consent of the copyright owner. The information presented in this document does not form part of any quotation or contract, is believed to be accurate and reliable and may be changed without notice. No liability will be accepted by the publisher for any consequence of its use.

[www.espentech.com](http://www.espentech.com)