

Responsible  
Outdoor Lighting  
Solutions

Liton®  
OUTDOOR



# INTRODUCTION

LITON's outdoor lighting collections are designed to be among the most cohesive and versatile in the industry. We focus on design consistency across all our products to create a harmonious look for your outdoor spaces. Our eight core commitments ensure we provide effective and responsible lighting solutions for any outdoor environment.

## Our Eight Core Commitments

### 1. Purposeful Lighting:

Every light should serve a clear purpose. That's why we offer a wide range of beam spreads, shapes, and colors to meet different needs.

### 2. Focused Illumination:

Light should only be directed where it's needed. Our fixtures are tiltable and rotatable for precise and intentional lighting.

### 3. Optimal Brightness:

Lighting should not be brighter than necessary. We offer multiple lumen options to achieve the perfect balance of brightness.

### 4. Energy Efficiency:

Lights should be dimmed or turned off when not in use. We support all standard dimming options, including 0-10V, Triac (Forward Phase), and (ELV - Reverse Phase) dimming.

### 5. Warm Color Temperature:

Use warmer light colors whenever possible. Our standard fixtures come with 2700K color temperatures for a welcoming ambiance.

### 6. U.S. Assembled:

We assemble our products in the USA and source components locally when possible to ensure quality and reliability.

### 7. Environmentally Friendly Options:

We offer Turtle Safe and Dark Sky-compliant fixtures to protect wildlife, and our nighttime skies.

### 8. Available for Canadian Markets:

All our exterior lighting products are available in 347V for the Canadian market.

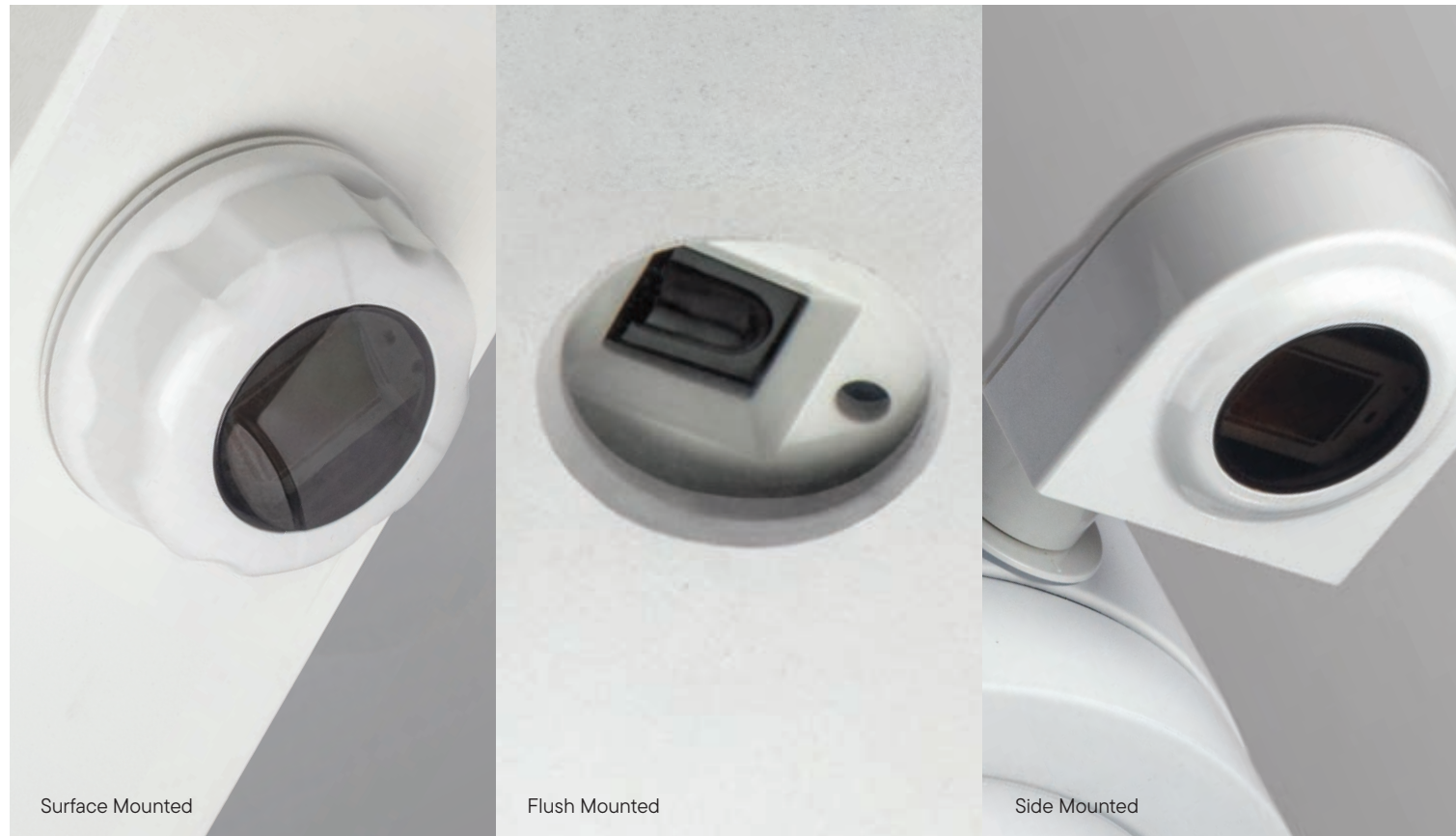

## Introducing UniSense™ Technology

UniSense™ technology integrates advanced microwave and PIR (Passive Infrared) sensors with daylight harvesting and dusk/dawn sensing capabilities. It adjusts lighting based on motion, presence, and ambient light levels, automatically dimming or brightening as needed. The system differentiates between natural and artificial light, providing optimized energy efficiency and precise control. It can be controlled via Bluetooth or remote, and is ideal for both indoor and outdoor applications, ensuring seamless and intelligent lighting management in various environments.

## PRODUCTS WITH UNISENSE™

Product	SKU	SDL (Integral Daylight)	INT (Integral Motion/Daylight)	RMT (Remote Motion/Daylight)
<b>AG2 SERIES PG. 8-15</b>				
	AGQ2340	•		
	AG2340	•		
	AG2360	•		•
	AG2380	•		•
<b>BOLLARDS/LUMENPOLE PG. 24-37</b>				
	BL7 21/ 22/ 31/ 32		•	
	BL 30/ 31/ 33	•		•
	BL4 31/ 34	•		•
	BL2R-RGBW		•	
	BL2R - 144/ 118/ 98/ 78		•	
	BL2R - 59/ 40/ 31	•		•
	BL2RZ - 144/ 118/ 98/ 78		•	
	BL2RZ - 59/ 40/ 31	•		•
	BL2QZ - 144/ 118/ 98/ 78		•	
	BL2QZ - 59/ 40/ 31	•		•
DL261RP		•		
WD261R		•		
<b>WD-SERIES PG. 38-45</b>				
	WD1340		•	
	WD1360		•	
	WD1Q340		•	
	WD1Q360		•	
	WD1340J	•		•
	WD1360J	•		•
	WD1Q340J	•		•
	WD1Q360J	•		•
	WD1Q362EM		•	
	WD2340	•		•
	WD2360		•	
	WD2Q340	•		•
	WD2Q360		•	
	WD1472/ 1473		•	
	WDQJ340		•	
WDJ340		•		
WDJ360		•		
<b>SCONCE LIGHTING PG. 46-47</b>				
	WS		•	
<b>DL-SERIES PG. 50</b>				
	DL340		•	
	DL360		•	
	DLQ340		•	
	DLQ360		•	
	DL340J	•		•
	DL360J	•		•
	DLCT340	•		•
	DLCTQ340	•		•
DLCT360	•		•	
DLQ360EM		•		

## SENSOR TYPES

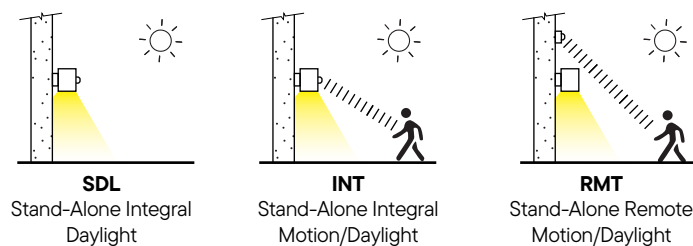

## ICONS

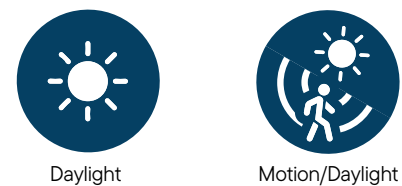

## DETECTION COVERAGE

Shown for ceiling mounted fixtures. For other mounting methods, refer to individual product specification pages

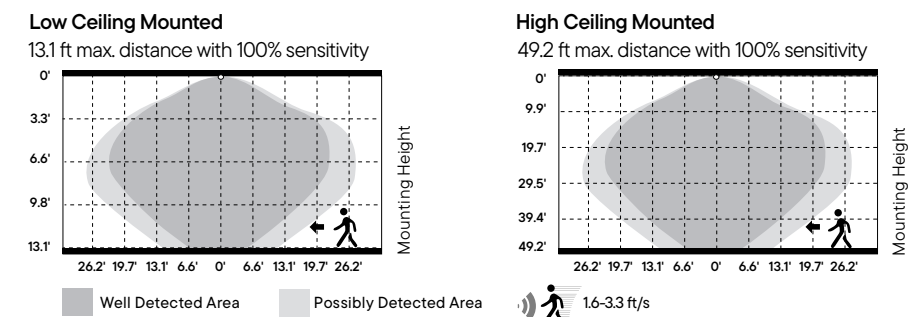

# TABLE OF CONTENTS



**6** RECESSED FLOOR MOUNT  
**IG IN-GRADE**



**8** ABOVE GRADE ACCENT/FLOOD  
**AG-SERIES**



**16** FLOOD/SPOT/RGBW  
**COLORONIX**



**24** PATHWAY LIGHTING  
**BOLLARDS**  
Custom Sizes Available



**28** BOLLARDS & COLUMNS  
**LUMENPOLE**



**36** WALL & PENDANT  
**LUMENPOLE**

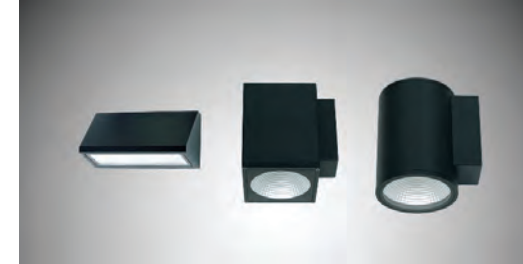

**38** WALL MOUNT DIRECTIONAL  
**WD-SERIES**



**44** WALL MOUNT ADJUSTABLE  
**BIONIC**

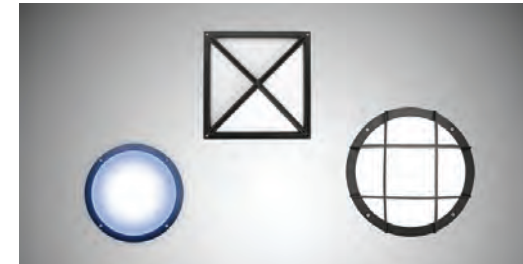

**46** WALL MOUNT SCNCE  
**SURFACE**



**48** STEP/PATHWAY LIGHTING  
**RECESSED**



**50** CEILING MOUNT DOWNLIGHT  
**DL-SERIES**



**52** CATENARY MOUNT DOWNLIGHT  
**DLCT-SERIES**

# IN-GRADE



Close-up of IG16 In-Grade shown in inset

IG14/IG16 luminaires are ideal for adding drama to the underside of tree canopies

## Recessed Floor Mount

In-grade luminaire designed for lighting trees, landscaping, soft ground installation, buildings, and walkways. Easily installs in ground and concrete.

### BENEFITS

- High Impact Lens (Drive Over Capable)
- Stainless Steel Ring
- Uniform, Low Glare Illumination
- 5-Year Limited Warranty
- 80+CRI Light Quality
- Singular COB Light Source
- IP65 Rated
- Frosted Lens & Slip Resistant Lens Options



Optional Frosted Lens (-FR) feature diffuses light for less glare.



**IG14**  
300lm (4W)  
4-11/16" D



**IG16**  
900lm/1200lm  
(10W/12W)  
5-15/16" D

### IG14/IG16 BEAM SPREADS

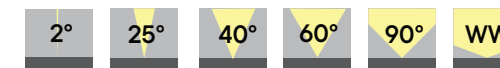

LINK TO WEB PAGE

# AG2·SERIES

Advanced outdoor lighting for controlled illumination.



## Accent/Spot/Flood

LITON introduces the new AG2-Series, a versatile family of commercial-grade IP65 rated accent, spot, flood lights, to bring sparkle and drama to your outdoor landscape lighting.

The low glare recessed singular COB luminaires include these exciting options:

NEW Variable Beam with field adjustable beam angle from 20° to 50° with clickable pre-set beam options.

RGBW color changing via Wireless Bluetooth or DMX512 for fine-tuned pastel colors and saturated hues.

### BENEFITS

- High lumen output up to 16,000LM (160W)
- Variety of mounting methods
- 120-277V/347V Input options
- Optional field adjustable Variable Beam, CCT, and dimming options
- Optional Glare Shield (-SH) to minimize glare









AG2340 shown with optional Glare Shield (-SH)

### Two Shapes, Three Sizes

4"	4"	6"	8"
			
<b>AGQ2340</b> 1000lm-1500lm (10W-15W) <b>SDL</b>	<b>AG2340</b> 1000lm-1500lm (10W-15W) <b>SDL</b>	<b>AG2360</b> 1000lm-2600lm (10W-30W) <b>RMT or SDL</b>	<b>AG2380</b> 7500lm-16,000lm (70W-160W) <b>RMT or SDL</b>

 **SDL** (Integral Daylight)     **RMT** (Remote Motion/Daylight)

STANDARD FINISHES				SPECIAL ORDER FINISHES			
							
White	Silver	Bronze	Black	Light Silver	Dark Gray	Metallic Gold	Metallic Black

					
Emergency Backup	US Assembled	120V	277V	347V Option	Turtle Safe Option

  
RGBW Option

  
**20°-50°**  
VARIABLE BEAM



LINK TO WEB PAGE

The underside of a tree canopy is illuminated by AG2360 in background



The AG2340 provides a dramatic accent to a tree canopy

## Accent/Spot/Flood

Lighting applications include:

- Uplight for ambience or directional Viewing
- Downlight for task lighting
- Accent/Spotlight to complement foliage
- Wall Wash to silhouette landscape plantings and foliage



LINK TO WEB PAGE

# AG2·SERIES

THE AG2-SERIES ILLUMINATES UP TO 100' AWAY!

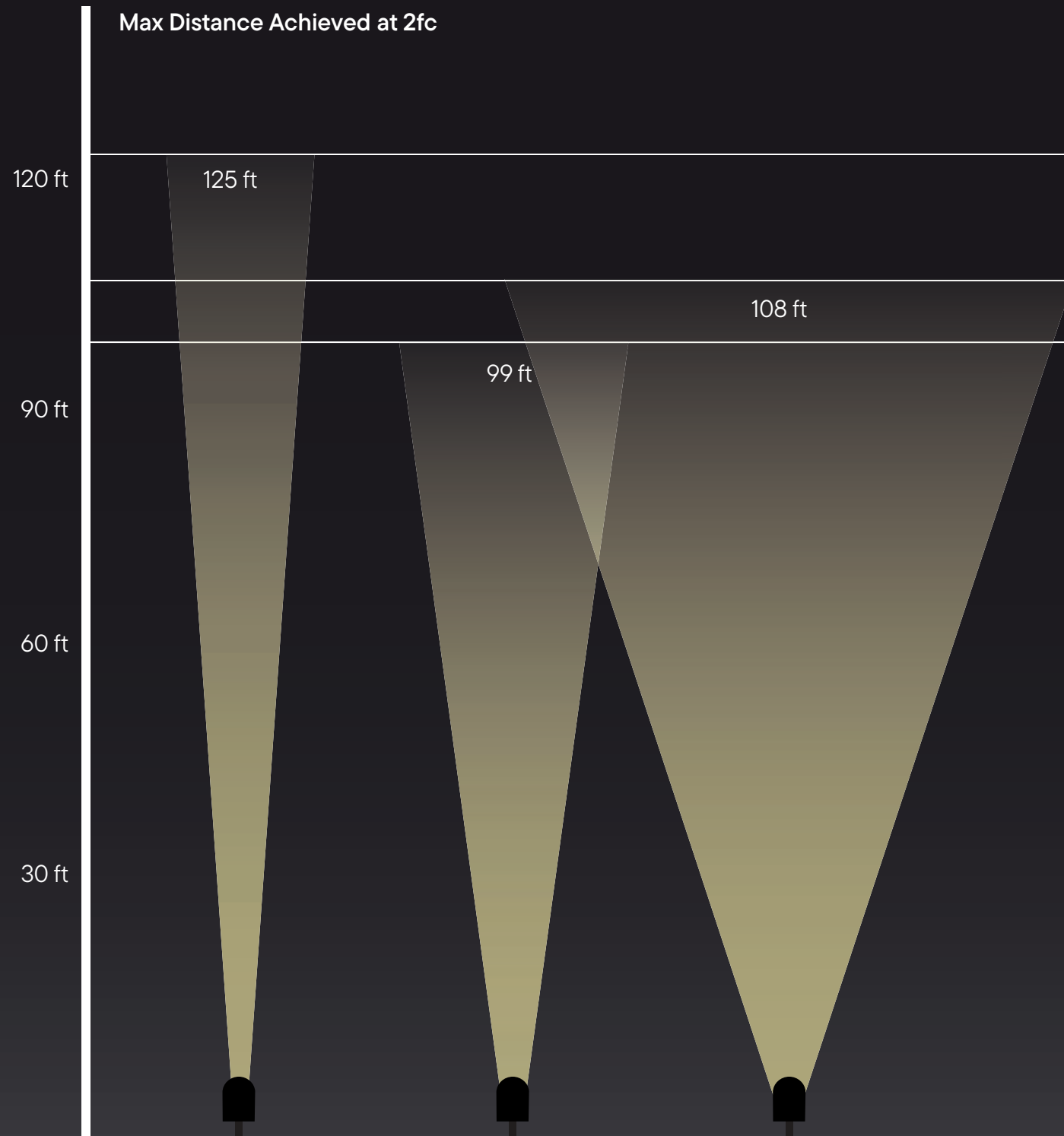

- Mini Spot**  
AG2340BZ-L15-B08UE-DUN  
(1500lm, 15W, 4000K)
- Narrow Spot**  
AG2360S-L26-B10UE-DUN  
(2600lm, 30W, 4000K)
- Flood**  
AG2340BZ-L15-B08UE-DUN  
(16,000lm, 160W, 4000K)

## Accent/Spot/Flood - Options



**Face Mount Emergency Back Pack Option**  
Feature is wet location rated and self diagnostic, operating from 120V to 347V with an integral surge protector

**RGBW Color Option**  
Feature allows fine-tuned pastel colors and saturated hues in millions of colors

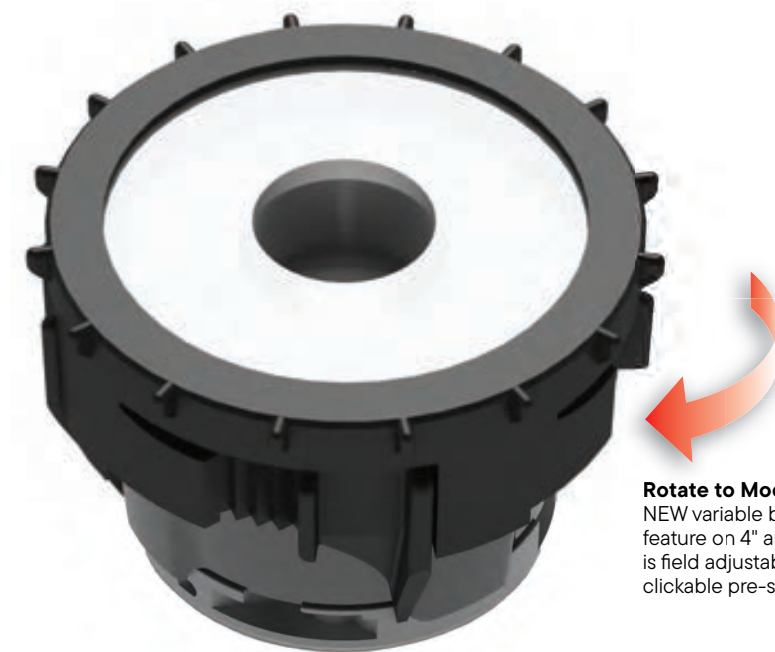

**Rotate to Modify Beam Angle**  
NEW variable beam option is a feature on 4" and 6" models, and it is field adjustable from 20° to 50° with clickable pre-set beam options

### STANDARD BEAMS

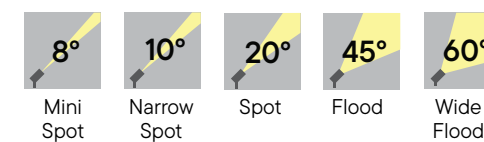

### SPECIALTY BEAMS

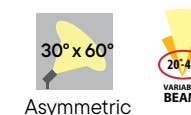

LINK TO WEB PAGE

# AG2·SERIES

## Suggested Lighting Applications

### A) Uplight

Fixtures are aimed away from the viewer and placed behind foliage to avoid glare and maintain a natural looking landscape.

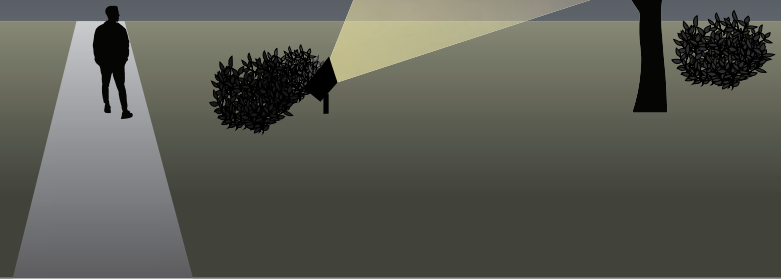

### B) Accent/Spotlight

Mount at grade level or overhead to accent details and specify (-SH) Shield to minimize glare.



### C) Downlight

For outdoor activity areas, place downlighting above eye level for safety and security. Fixtures can be mounted to building facades or trees.

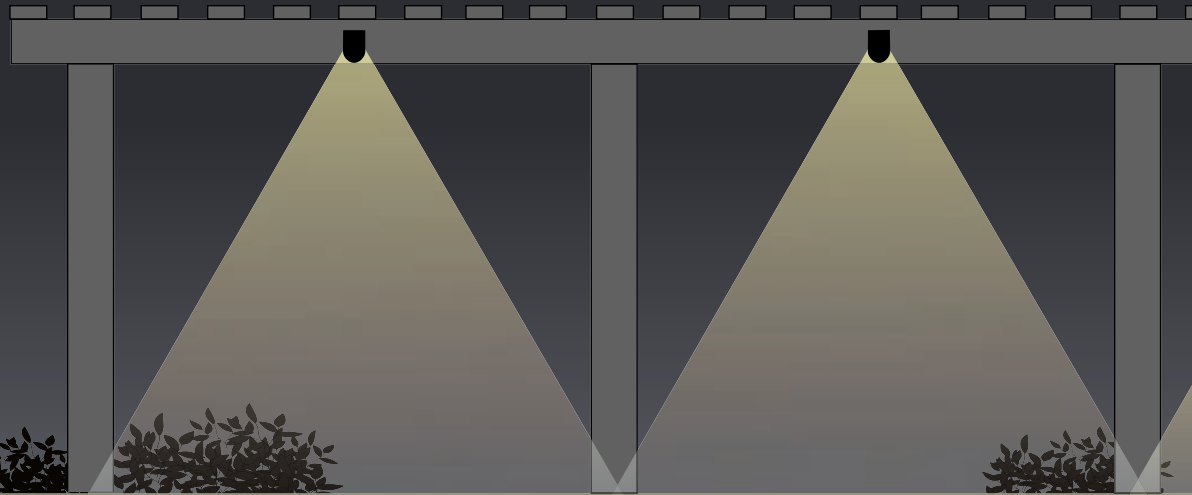

### D) Moonlight

A combination of up and downlighting creates the effect of moonlight, bringing a sense of mystery with highlight and shadow accents.



### E) Wall Wash/Silhouette

Natural foliage is dramatic when silhouetted against a wall washed with light. Wall Washes provide uniformity when lighting signs and flagpoles.

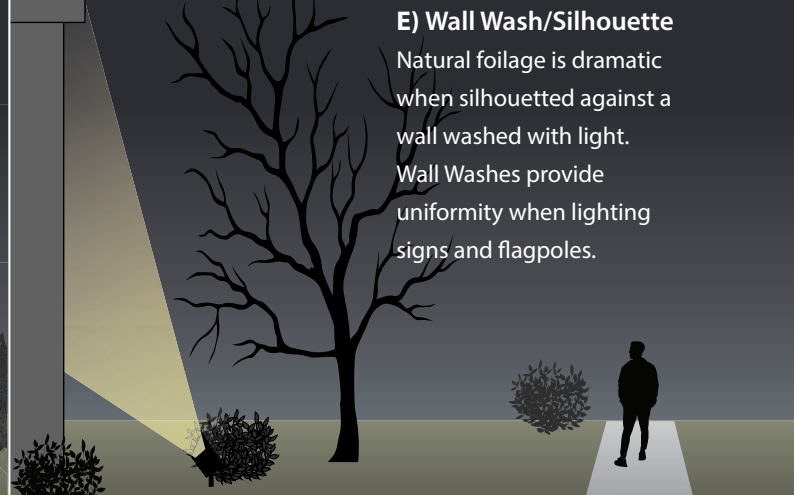

## Accent/Spot/Flood - Mounting



AG2340 with Tenon Reducer Hub for mounting two luminaires on a pole

AG2340 with L-Connector and Stem for sign lighting

## Mounting Methods/Options

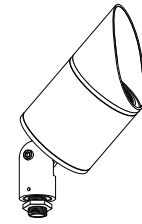

1/2" IPS  
Threaded

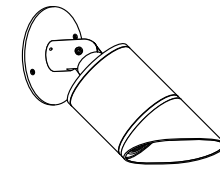
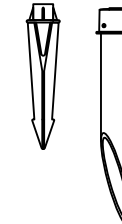
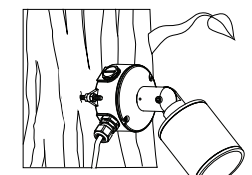

Plate Mount  
(-PL)



Stake Mount  
/AG2-SPK  
/AG2-SPK-AC



Tree Mount  
Fixture w/ (-JB)

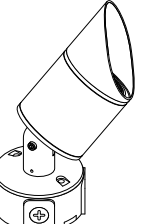

Integral J-Box  
(-JB)

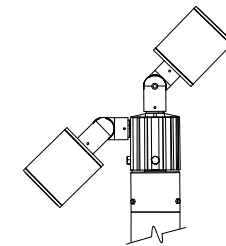

Pole Top Mount  
(/AG2-TRH-1/2)

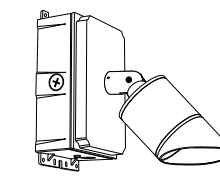

Integral Emergency  
Mount (/AG2-EMB)

## Stem Configurations

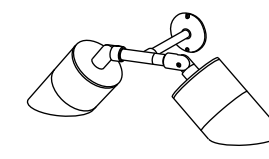

T-Connector  
(/AG2-T)

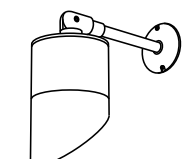

Stem Coupler  
(/AG2-CPL)

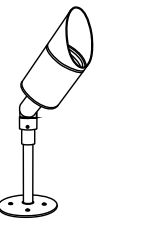

6" Stem Mount  
(/AG2-STM06)



LINK TO WEB PAGE

Your building is now your canvas.

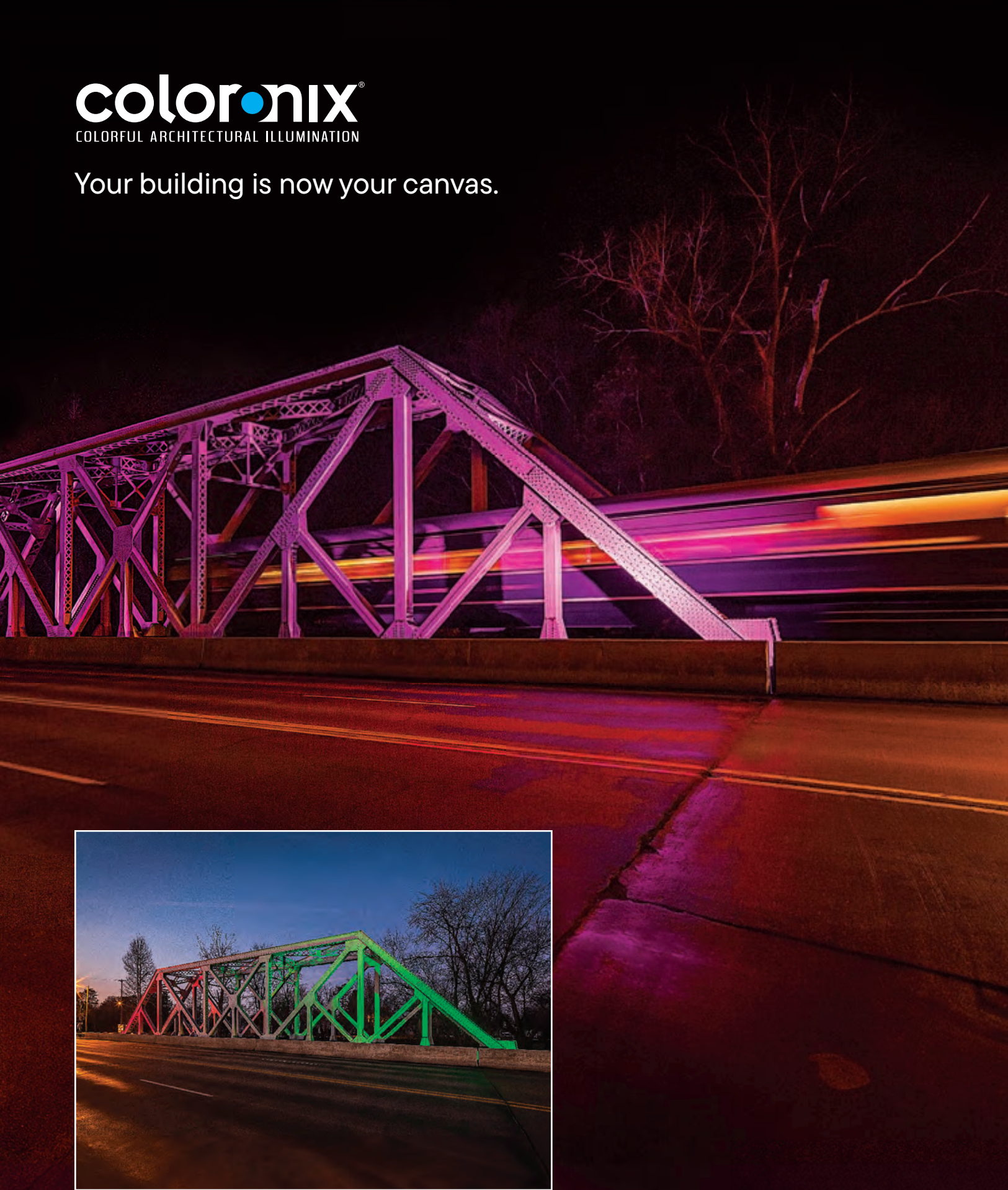

ColorRay static and dynamic color changing

## ColorFlood

Intuitive, easy to use, and with a wide variety of options, the ColorFlood series provides spot and flood LED color changing at the push of a button. Designed for retail, hospitality, high-end residential and a host of other applications, these fixtures come in four output configurations and a wide variety of lensing options.

### BENEFITS

- IP66 Available by special order
- Smooth and flicker-free dimming of all colors down to 1%
- Multiple Beam Spreads

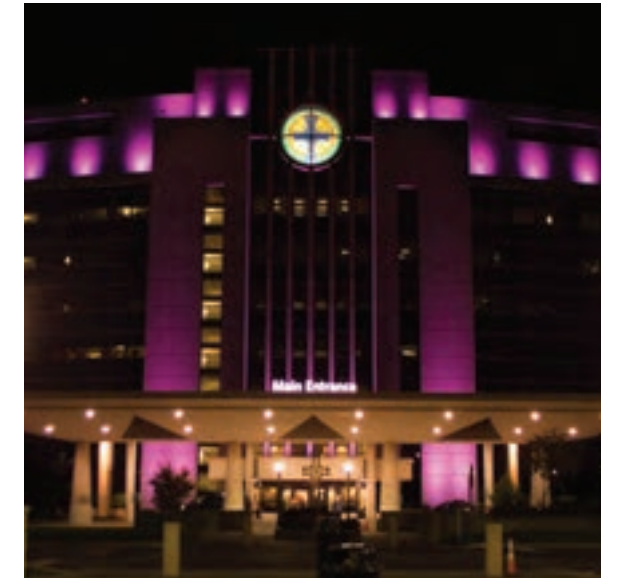

ColorRay static and dynamic color changing

## Adjustable Flood/Spot Lighting



**SS2-RGBW-8R-04**  
ColorFlood  
4 LED  
1100lm (32W)  
5-1/2" D



**SS2-RGBW-8R-10**  
ColorFlood  
10 LED  
2500lm (80W)  
8-1/4" D



**SS2-RGBW-8R-15**  
ColorFlood  
15 LED  
3500lm (110W)  
9-1/2" D



**SS2-RGBW-120R**  
ColorFlood  
4000lm (120W)  
10" D



**SS2-RGBW-10S-24**  
ColorFlood  
24 LED  
5200lm (161W)  
10-3/4" H x 4" W x 15-3/16" L



### Internamix

Provides smooth  
1-color light output



### RGBW

One Red, Green, Blue  
and White LED for a  
true white



### DMX Direct

Four-channel DMX  
address for each unit



### ColorRay™

Pre-programmed  
data-enabled fixtures  
come standard



LINK TO WEB PAGE



## ColorFacade

Energy efficient, User-Friendly and Stunningly clean optics give these Graze/Wall Wash fixtures a unique place in the market. Designed for use in retail, hospitality, corporate settings and a variety of other markets.

### BENEFITS

- DMX direct via LCD display
- Multiple beam spreads
- Proprietary quick connectors included
- Static Colors Available
- InternaMix™ proprietary technology
- Smooth and flicker-free dimming to 1%
- 3-Year Warranty

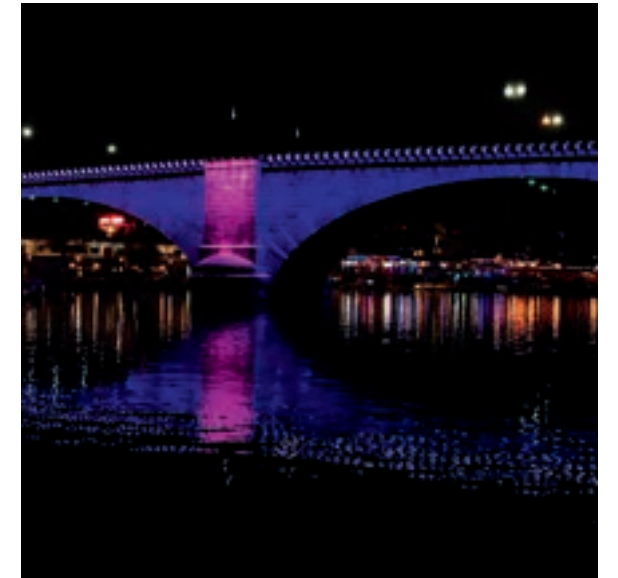

ColorRay static and dynamic color changing

## Adjustable Linear Flood/Graze Wall Wash

SS2-5L-16  
40" Color Facade  
16 LED  
3000lm (76W)



SS2-18L-18  
40" Color Facade  
18 LED  
5250lm (105W)



### InternaMix

Provides smooth 1-color light output



### RGBW

One Red, Green, Blue and White LED for a true white



### DMX Direct

Four-channel DMX address for each unit



### ColorRay™

Pre-programmed data-enabled fixtures come standard



LINK TO WEB PAGE



SS6-RGB-3R and SS6-RGB-6R bring dynamic effects to water features

## Underwater & Landscape

Designed to enhance landscape, trees, signage and water features. For smaller projects requiring minimal color changing flood lighting. RGBW design allows fine-tuned pastel colors, saturated hues without sacrificing illumination brightness.

### BENEFITS

- DMX direct via data enabler
- Static Colors Available
- InternaMix™ proprietary technology
- Smooth and flicker-free dimming to 1%
- 3-Year Warranty



SS3-RGBW-3R Pathway

## Low Voltage



SS6-RGB-3R  
3-3/4" Underwater  
350lm (15W)



SS6-RGB-6R  
5" Underwater  
650lm (30W)



SS3-RGBW-3R  
5-1/8" Pathway  
481lm (15W)



SG3-RGBW-1R  
5-1/8" In-Ground  
(6W) Low Voltage



### InternaMix

Provides smooth  
1-color light output



### RGBW

One Red, Green, Blue  
and White LED for a  
true white



### DMX Direct

Four-channel DMX  
address for each unit



### ColorRay™

Pre-programmed  
data-enabled fixtures  
come standard



LINK TO WEB PAGE



## Controls

From simple to complex, Coloronix has a solution to handle your lighting system. All Coloronix products are fully controllable via DMX for those who want to bring their own control solution to the table.



### DMX Controllers



**SCC5**  
ColorRay™  
Signal Receiver &  
Remote Control  
12V DC 0.65A

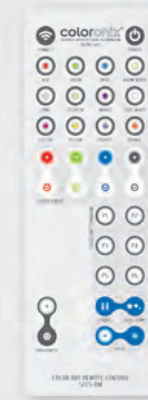

**SCC9**  
Multi-Zone  
120VAC



**SCC11**  
Color Control  
Touch Zone Controller  
5-10V DC 0.6A



**Internamix**  
Provides smooth  
1-color light output



**RGBW**  
One Red, Green, Blue  
and White LED for a  
true white



**DMX Direct**  
Four-channel DMX  
address for each unit



**ColorRay™**  
Pre-programmed  
data-enabled fixtures  
come standard



LINK TO WEB PAGE

# BOLLARDS - BL7



B721 bollard shown in inset



BL732 bollard shown in background

## Pathway Lighting

LITON 8"x 4" Rectangular Scoop and Trapezoid single and double head bollards are designed for outdoor applications where Dark Sky compliant illumination is required, and they enhance the safety, security, and visual appeal of outdoor spaces.

### BENEFITS

- Dark Sky compliant
- Sleek architectural design
- Durable, corrosion resistant finish
- 5-year limited warranty
- 120V/277V UniDim™ 0-10V ELV & Triac dimming to 5%
- Frosted lens option

### 8" x 4" Rectangular Bollards



**BL721 (Scoop)**  
H: 20", 40"  
850lm (15W)  
Also available in Amber  
**INT**



**BL731 (Trapezoid)**  
H: 20", 40"  
850lm (15W)  
Also available in Amber  
**INT**



**BL722 (Double Scoop)**  
H: 20", 40"  
2 x 850lm (2 x 15W)  
**INT**



**BL732 (Double Trapezoid)**  
H: 20", 40"  
2 x 850lm (2 x 15W)  
**INT**

**INT** (Integral Motion/Daylight)



Optional Frosted Lens feature

STANDARD FINISHES

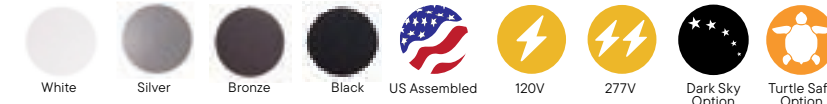

Custom Sizes Available



LINK TO WEB PAGE

# BOLLARDS - BL3/BL4

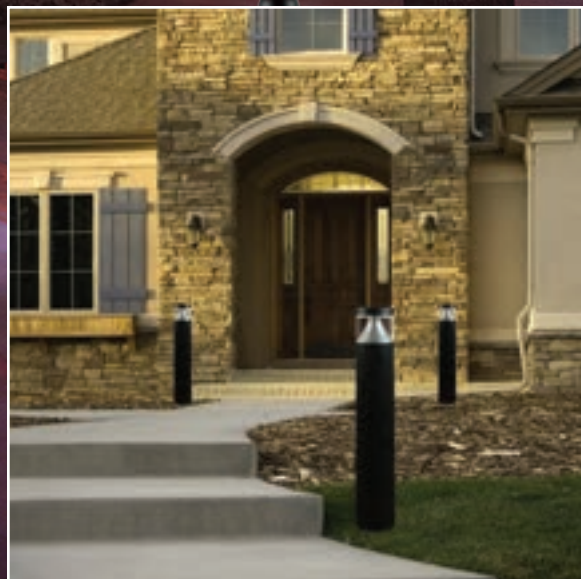
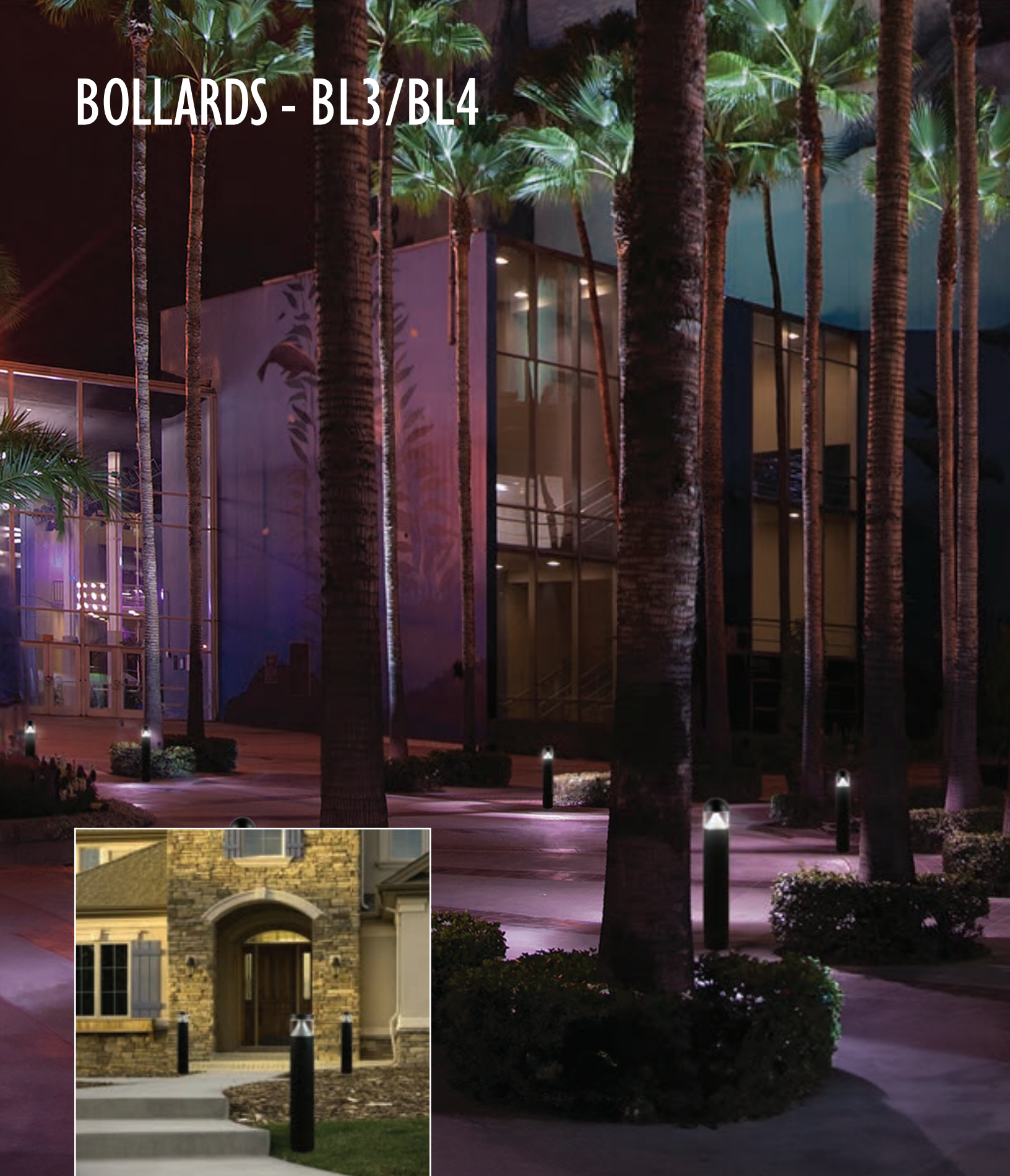

BL31 shown in inset

BL30 Bollards are ideal in courtyards and building entrances

## Pathway Lighting

LITON 7" Round bollards are available in various designs and finishes to complement different architectural styles and landscaping themes and to enhance the safety, security, and visual appeal of outdoor spaces.

### BENEFITS

- Dark Sky compliant on selected models
- Sleek architectural design
- Durable, corrosion resistant finish
- 5-year limited warranty
- Type IV IES distribution available on BL30 & BL31

### 7" Round Bollards



**BL30**  
Cone (Round Top)  
H: 39-5/16"  
2300lm (28W)  
RMT or SDL



**BL31**  
Cone (Flat Top)  
H: 37-3/16"  
2300lm (28W)  
RMT or SDL



**BL31 Amber Cone**  
(Flat Top)  
H: 37-3/16"  
849lm (28W)  
RMT or SDL



**BL431**  
(Round Top)  
H: 37-1/2"  
324lm (15W)  
RMT or SDL



**BL33**  
Pyramid (Round Top)  
H: 38-1/16"  
600lm (26W)  
RMT or SDL



**BL434**  
(Flat Top)  
H: 38-1/8"  
324lm (15W)  
RMT or SDL

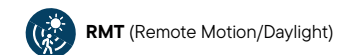

Custom Sizes Available



Integral or Remote Battery Backup is a feature on selected models

STANDARD FINISHES



LINK TO WEB PAGE

# LUMENPOLE

A consistent look from the parking lot to the lobby.



Available with  
Top Mount Spotlight

**BL2RZ**  
Round Open Frame  
31" to 144" H  
500LM - 2600lm  
(8W - 50W)

**BL2R**  
Round Frosted Lens  
31" to 144" H  
1200lm - 3100lm  
(13W - 30W)

**BL2QZ**  
Square Open Frame  
31" to 144" H  
500LM - 3000lm  
(8W - 50W)

## Bollards & Columns

LumenPole Bollards and Columns are designed for decorative lighting, way-marking, public areas, driveways, and access roads. Integrating form and function in architecturally relevant sizes, LumenPole effortlessly scales to fit any outdoor space.

By progressively decreasing the height of the luminaire, the fixtures serve as a way finder, pointing the way to the building entrance as pedestrians move closer to a building.

### BENEFITS

- 6" Round Frosted Lens or Open Frame
- 6" Square Open Frame
- From 31" to 144" H
- Up to 3100lm (50W) delivered
- Dark Sky compliant
- Tamper resistant hardware
- IK08 impact rating
- RGBW, photocell & integral emergency options
- Full IES files available

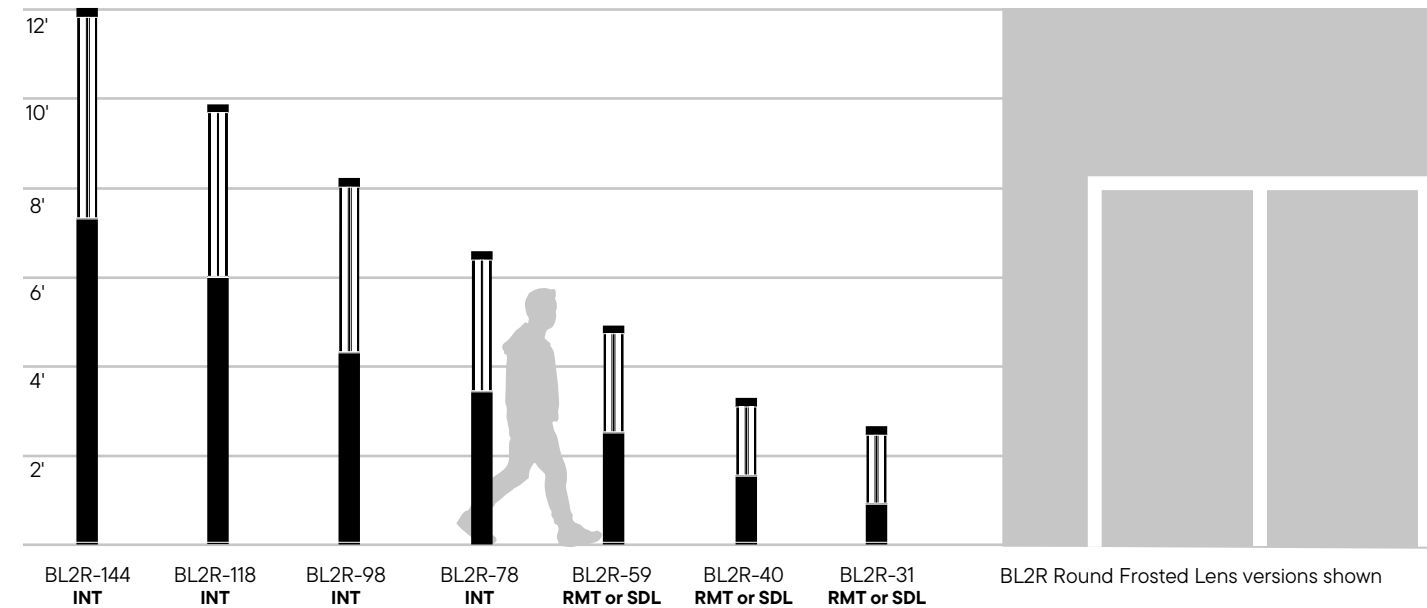

- SDL** (Integral Daylight)
- RMT** (Remote Motion/Daylight)
- INT** (Integral Motion/Daylight)

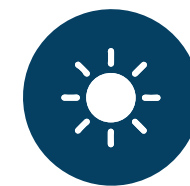

Daylight



Motion/Daylight

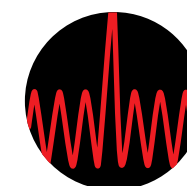

Surge Protector feature to protect and enhance longevity



Integral Battery feature for illumination during power outages

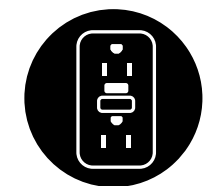

GFCI & In-Use Cover feature to minimize risk and ensure the reliability



LINK TO WEB PAGE

# LUMENPOLE

## ROUND FROSTED LENS



BL2R-78 RGBW shown in inset

### Round Frosted Lens

LumenPole Round Frosted Lens Bollards and Columns feature an opal acrylic lens to provide uniform light distribution for consistent brightness and reduced glare and harsh shadows throughout the illuminated area.

#### BENEFITS

- 6" Round from 31" to 144" H
- Up to 3100lm (30W) delivered
- Tamper resistant hardware
- IK08 impact rating
- RGBW, photocell & integral emergency options
- Full IES files available



BL2R Round Frosted Lens shown in outdoor and retail food court settings

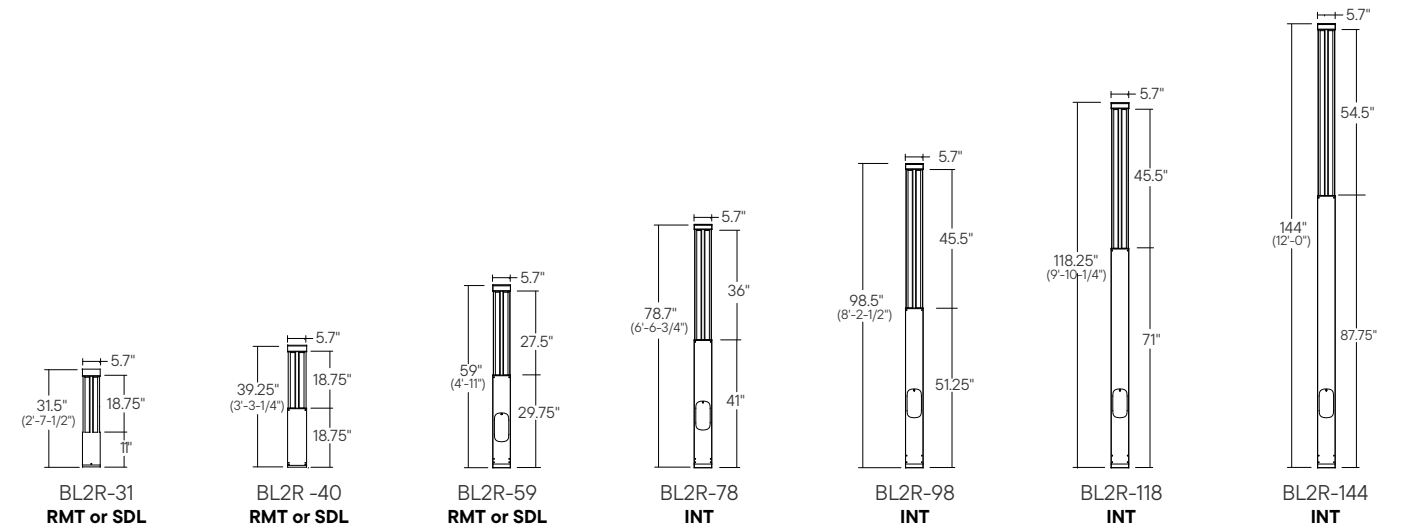

- SDL** (Integral Daylight)
- RMT** (Remote Motion/Daylight)
- INT** (Integral Motion/Daylight)



- RGBW Option
- US Assembled
- 120V
- 277V
- 347V Option
- IK08



LINK TO WEB PAGE

# LUMENPOLE

## ROUND OPEN FRAME



BL2RZ-98 shown in inset and background

## Round Open Frame

LumenPole Round Open Frame Bollards and Columns feature a smooth, cylindrical shape to provide even illumination in all directions enhancing visibility and safety. The COB LED with reflector provides illumination downward on the ground to light walkways, and other public and private gathering spaces.

### BENEFITS

- 6" Round from 31" to 144" H
- Up to 2600lm (50W) delivered
- Dark Sky compliant
- Tamper resistant hardware
- IK08 impact rating
- Photocell & integral emergency options
- Full IES files available



BL2RZ Round Open Frame shown outdoors and adjacent to a parking garage

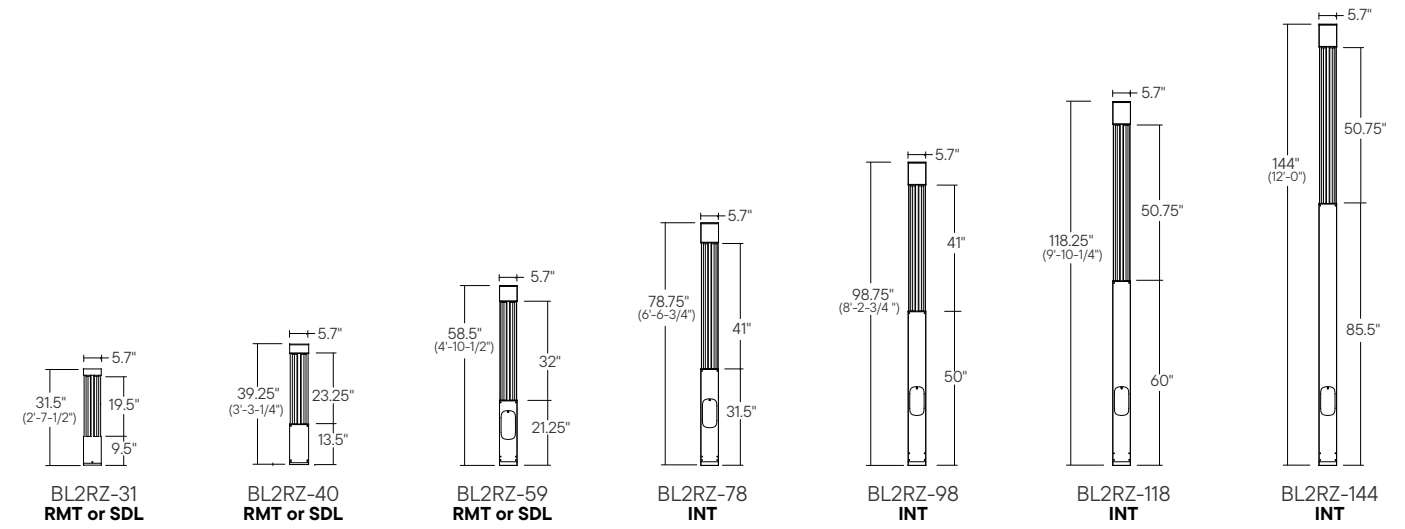

- SDL** (Integral Daylight)
- RMT** (Remote Motion/Daylight)
- INT** (Integral Motion/Daylight)



- Emergency Backup
- US Assembled
- 120V
- 277V
- 347V Option
- Dark Sky Option
- Turtle Safe Option
- IK08



LINK TO WEB PAGE

# LUMENPOLE

## SQUARE OPEN FRAME



BL2QZ-31 shown in inset

BL2QZ-59 and BL2QZ-144 shown in background

## Square Open Frame

LumenPole Square Open Frame Bollards and columns feature clean, angular lines for spaces that require stronger architectural presence and a more defined light pattern. The COB LED with reflector provides illumination downward on the ground to light walkways, and other public and private gathering spaces.

### BENEFITS

- 6" Square from 31" to 144" H
- Up to 2600lm (50W) delivered
- Dark Sky compliant
- Tamper resistant hardware
- IK08 impact rating
- Photocell & integral emergency options
- Full IES files available



BL2RZ Square Open Frame



40", 59", 78", 98", 118" & 144" Bollards & Columns feature easy, yet secure tamper resistant access through side-entry electrical panel

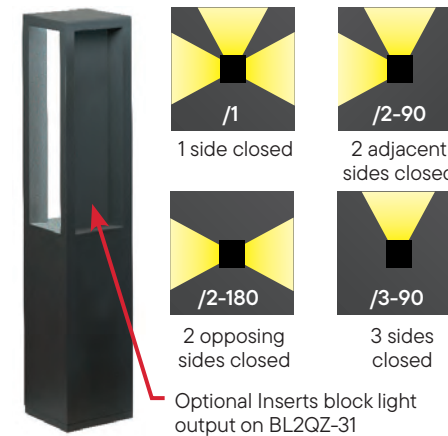

Optional Frosted Lens feature for BL2QZ 40" to 144"



Optional DMX 512 Remote Mounted Decoder feature for BL2QZ-RGBW

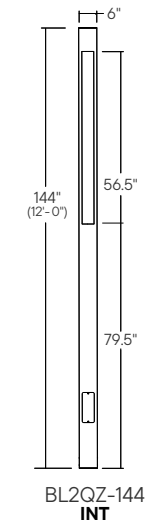
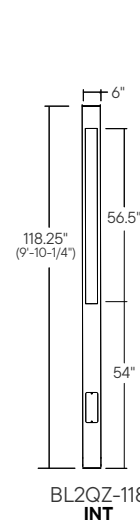
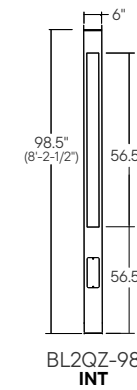
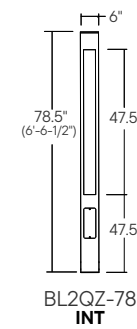
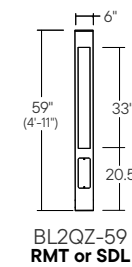
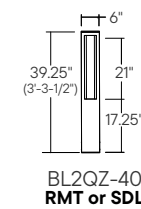
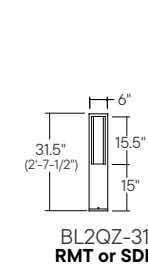

SDL (Integral Daylight)



RMT (Remote Motion/Daylight)



INT (Integral Motion/Daylight)

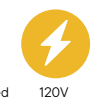

LINK TO WEB PAGE

# LUMENPOLE

ROUND FROSTED LENS  
WALL & PENDANT

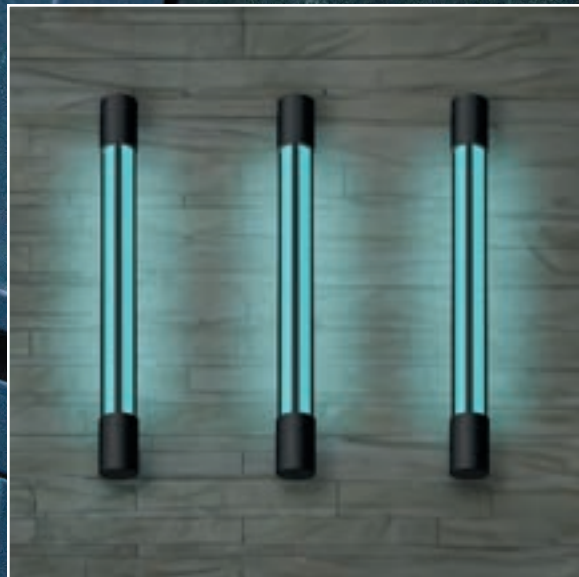

WD261R with RGBW feature is shown highlighting a building entrance

## Round Frosted Lens Wall & Pendant

LumenPole Wall and Pendant Frosted Lens versions extend the product line all the way into the building. Wall mount versions can be mounted up or down. RGBW color changing is also available.

### BENEFITS

- 6" Round
- 1200lm-7300lm (13W-85W)
- Wall mount available with uplight & downlight
- Pendant available with downlight
- IK08 Impact Rating
- RGBW, and Photocell, options
- 12", 24" & 36" Pendant stem heights
- 5-year warranty
- Standard UniDim™ for all except (-RGBW)

### Pendant Stem Mounts



**DL261RP-19**  
19" Frosted Lens  
Downlight/no Downlight  
1200lm-3800lm  
(13W-43W)  
INT



**DL261RP-28**  
28" Frosted Lens  
Downlight/no Downlight  
1700lm-4300lm  
(20W-50W)  
INT



**DL261RP-36**  
36" Frosted Lens  
Downlight/no Downlight  
2100lm-4700lm  
(25W-50W)  
INT

### Downlight Options

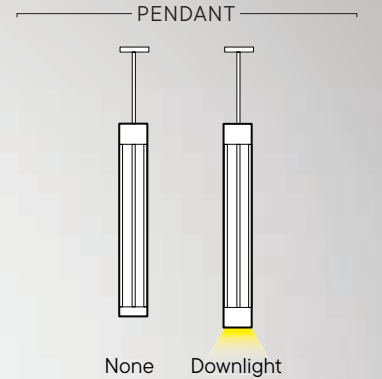

### Wall Mount



**WD261R-19**  
19" Frosted Lens  
Single Arm  
Uplight/Downlight  
1200lm-4100lm  
(13W-48W)  
INT



**WD261R-28**  
28" Frosted Lens  
Double Arm  
Uplight/Downlight  
1700lm-6900lm  
(20W-80W)  
INT



**WD261R-36**  
36" Frosted Lens  
Double Arm  
Uplight/Downlight  
2100lm-7300lm  
(25W-85W)  
INT

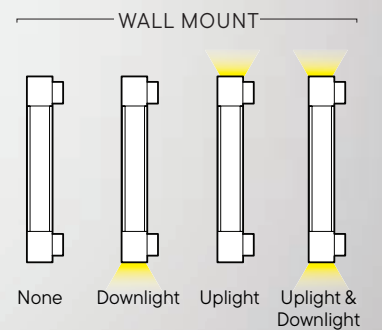

 INT (Integral Motion/Daylight)

#### STANDARD FINISHES

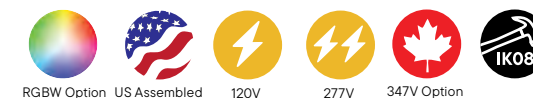

Optional Glare Shield feature



PENDANT WEB PAGE



WALL MNT. WEB PAGE

# WD-SERIES

Versatile luminaires for precise directional lighting.

WD1360J Adjustable shown in background



WD1360 Downlight shown in inset

## Wall Mount Directional

LITON's WD-Series 1-direction wall luminaire can be pointed up or down and used as downlight for direct illumination or uplight for indirect illumination of architecture facades.

### BENEFITS

- Energy efficient, low glare LED Chip-On-Board light engine
- 1-Direction is available with Standard, Cleanbeam™ or Specialty beams
- 1-Direction Adjustable is available with 45° Flood or 60° Wide Flood
- 5-Year Limited Warranty
- Integral Emergency Option!

### 1-Direction Downlight



**WD1340**  
4" Round  
1000lm-1500lm  
(15W-22W)  
INT



**WD1360**  
6" Round  
1000lm -2600lm  
(15W-30W)  
INT



**WD1Q340**  
4" Square  
850lm (15W)  
INT



**WD1Q360**  
6" Square  
1000lm -2600lm  
(15W-30W)  
INT

### 1-Direction Adjustable



**WD1340J**  
4" Round Adjustable  
700lm (9W)  
RMT or SDL



**WD1360J**  
6" Round Adjustable  
1500lm (15W)  
RMT or SDL



**WD1Q340J**  
4" Square Adjustable  
700lm (9W)  
RMT or SDL



**WD1Q360J**  
6" Square Adjustable  
1500lm (15W)  
RMT or SDL



SDL (Integral Daylight)



RMT (Remote Motion/Daylight)



INT (Integral Motion/Daylight)

4" & 6" DOWNLIGHT

STANDARD BEAMS				CLEANBEAM™			SPECIALTY BEAMS		

ADJUSTABLE DOWNLIGHT

4" STANDARD BEAMS				6" STANDARD BEAMS			

STANDARD FINISHES				SPECIAL ORDER FINISHES			
White	Silver	Bronze	Black	Light Silver	Dark Gray	Metallic Gold	Metallic Black
RGBW Option	Emergency Backup	US Assembled	120V	277V	347V Option	Dark Sky Option	Turtle Safe Option

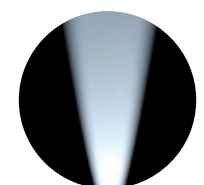

CleanBeam feature for uniform light output



LINK TO WEB PAGE

# WD-SERIES



WD2360 with Integral Emergency Back Pack (-EMB-SD) feature shown in inset

WD2360 with RGBW option shown in background

## Wall Mount Bi-Directional

LITON's 2-direction wall luminaire's dual reflector design allows for direct and indirect lighting from a single fixture. Typical locations are in commercial and retail spaces that contain walls and/or columns that require directional lighting.

### BENEFITS

- Energy efficient, low glare LED Chip-On-Board light engine
- Standard, Cleanbeam™ or Specialty beam options
- Integral & remote Emergency options available
- 5-Year Limited Warranty

### 2-Direction Up/Down



**WD2340**  
4" Round  
2 x 1000lm (30W)  
RMT or SDL



**WD2360**  
6" Round  
2 x 1000lm-2600lm  
(30W-64W)  
INT



**WD2Q340**  
4" Square  
2 x 850 lm (30W)  
RMT or SDL



**WD2Q360**  
6" Square  
2 x 1000lm -2600lm  
(30W-64W)  
INT

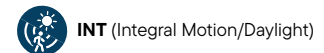
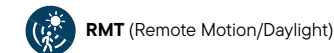

### Options

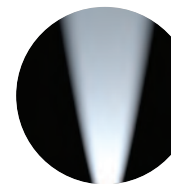

CleanBeam feature for uniform light output

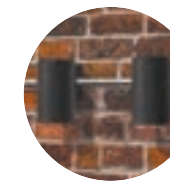

Direct Conduit J-Box entry feature for in-line installation

#### STANDARD BEAMS



#### CLEANBEAM™

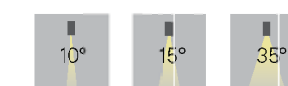

#### SPECIALTY BEAMS

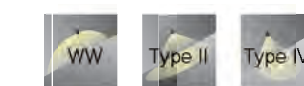

STANDARD FINISHES				SPECIAL ORDER FINISHES			
White	Silver	Bronze	Black	Light Silver	Dark Gray	Metallic Gold	Metallic Black
RGBW Option	Emergency Backup	US Assembled	120V	277V	347V Option	Dark Sky Option	Turtle Safe Option



LINK TO WEB PAGE

# WD-SERIES

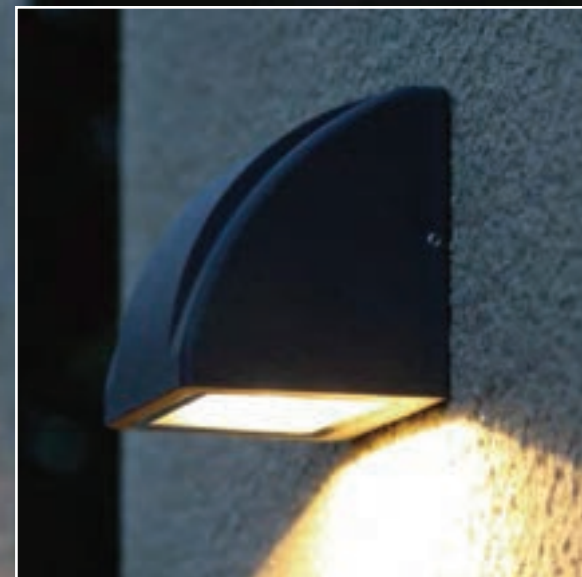

WD1473 Trapezoid shown in background

WD1472 Scoop shown in inset

## Wall Mount Scoop/Trapezoid

The Scoop/Trapezoid single reflector design can be used for direct illumination downward or indirect illumination upward. The fixtures are dark sky compliant, and also available in an optional Florida Fish and Wildlife Turtle Safe approved version.

### BENEFITS

- Sleek architectural design
- Durable, corrosion-resistant finish
- Emergency back up available
- 5-year limited warranty
- Now with Integral Emergency Option!

### Scoop/Trapezoid



**WD1472 8" (Scoop)**  
8" x 4" Rectangle  
850lm (15W)  
INT



**WD1473 (Trapezoid)**  
8" x 4" Rectangle  
850lm (15W)  
INT

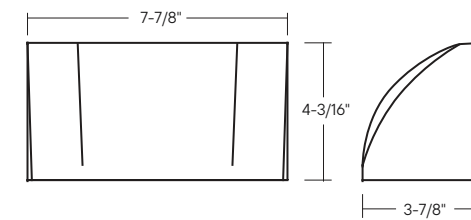
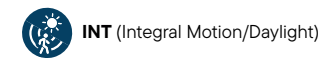

WD1472

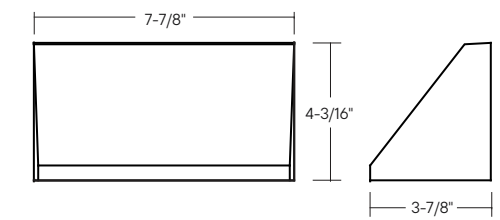

WD1473

### STANDARD BEAMS



STANDARD FINISHES				SPECIAL ORDER FINISHES				
White	Silver	Bronze	Black	Light Silver	Dark Gray	Metallic Gold	Metallic Black	
RGBW Option	Emergency Backup	US Assembled	120V	277V	347V Option	Dark Sky Option	Turtle Safe Option	ADA Compliant



LINK TO WEB PAGE

# BIONIC



WDJ340 with Integral Emergency Back Pack (-EMB-SD) feature shown in inset

## Wall Mount Bi-Directional

LITON's New Bionic bi-directional luminaire combines a wall mounted downlight with a spotlight to create a dynamic, visually striking outdoor environment. It can be mounted in an up or down configuration for additional versatility.

### BENEFITS

- 120-277V Input options
- Glare Shields for eye comfort
- Multiple Beam Spreads & Color Temperatures
- Integral J-box option
- Emergency Back-Pack option
- Available with Type IV/Forward Throw

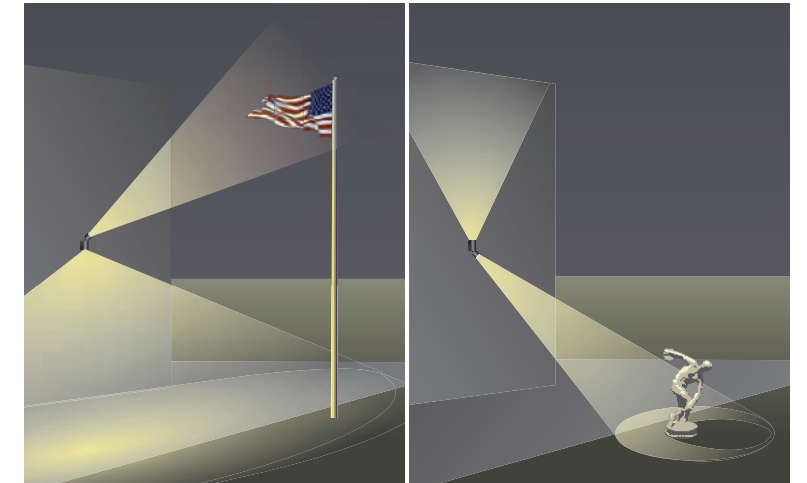

Downlight & Spotlight

Uplight & Spotlight



**WDQJ340**  
4" Square  
2 x 1000lm/1500lm  
(20W/30W)  
INT



**WDJ340**  
4" Round  
2 x 1000lm/1500lm  
(20W/30W)  
INT



**WDJ360**  
6" Round  
2 x 1000lm - 2600lm  
(20W to 60W)  
INT

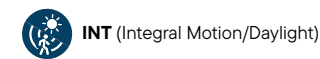

STANDARD FINISHES				SPECIAL ORDER FINISHES			
White	Silver	Bronze	Black	Light Silver	Dark Gray	Metallic Gold	Metallic Black
RGBW Option	Emergency Backup	US Assembled	120V	277V	347V Option	Tamper Resistant	



LINK TO WEB PAGE

# WALL/CEILING

WS700C Open Face shown in background

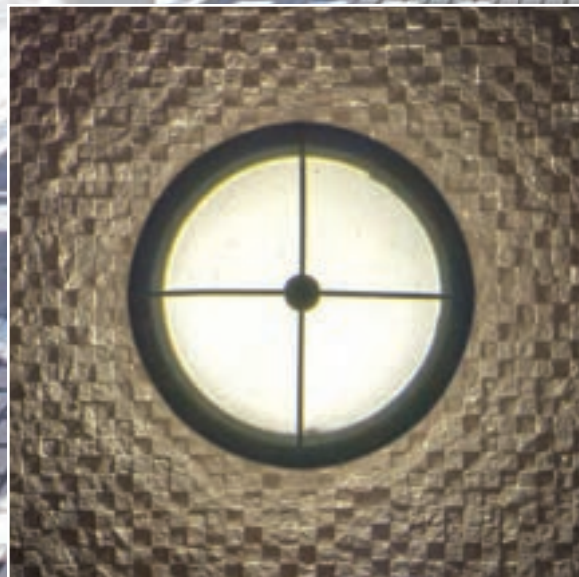

WS730C Bulls-Eye shown in inset

## Sconce Lighting

Surface, ceiling or wall mount Sconce  
Luminaires are ideal for indoor or outdoor applications that require the fixture to integrate into the design of the structure.

### BENEFITS

- Impact Resistant
- Diffusing Lens.
- Tamper Proof Hardware
- 80+CRI Light Quality
- ADA Compliant
- IP65 Rated
- RGBW Option

### WS7-Series 10" Round

600lm-1500lm (10W/15W) except where noted

 INT (Integral Motion/Daylight available for all WS products)



WS730C  
Bulls-Eye



WS730C  
Decorative Cross Bar



WS733S  
Guard Bar



WS750S  
Half Lid



WSQ234S  
11" Square  
500LM (13W)



WS770S  
Vanguard



WS734C  
Cross Bar



WS700C  
Open Face

### WS8-Series 14" Round

600lm-1500lm (10W/15W) except where noted



WS800  
Open Face



WS804  
Vertical & Horizontal



WS830  
Cross Bar



WS833  
Guard Bars



WS834  
Cross Bars

#### STANDARD FINISHES



White Silver Bronze Black



RGBW Option



Emergency Backup



US Assembled



120V



277V



ADA Compliant



Tamper Resistant



LINK TO WEB PAGE

# STEP/PATHWAY

12" Flat Recessed (SL120) shown in background



Open Lens Vertical (LSLD00) shown in inset.

## Recessed Wall Mount

Die-cast Wall Luminaires for low mounting heights on steps, walkways, and other indoor and outdoor applications.

### BENEFITS

- No remote driver required
- ELV Dimmable
- Die-cast
- 5-year warranty
- ADA compliant

### 2.5" Square or Round & 2" x 3" Rectangle



**LSLDQ00**  
Open Lens Square  
240lm (3.5W)



**LSLDQ73**  
Square Louver  
240lm (3.5W)



**LSLDR00**  
Open Lens Round  
240lm (3.5W)



**LSLDR73**  
Round  
Glare-Free Louver  
240lm (3.5W)



**LSLD00**  
Open Lens Vertical  
44.5lm (2.7W)



**LSLDH00**  
Open Lens Horizontal  
240lm (3.5W)  
Also available in Amber



**LSLD73**  
Vertical  
Rectangular Baffle  
240lm (3.5W)  
Also available in Amber



**LSLDH73**  
Horizontal  
Rectangular Baffle  
240lm (3.5W)  
Also available in Amber

### 7" to 12" Recessed



**SL120**  
12" Flat Recessed  
150lm (5W)



**SL600**  
9" Open Face  
800lm (9W)



**SL632**  
9" Angled Louver  
300lm (9W)



**SL630**  
9" Louver Face  
600lm (9W)  
Also available in Amber



**SL650**  
9" Half Lid Faceplate  
800lm (9W)



**SL700**  
11" Open Face  
1000lm/1500lm  
(11W/20W)



**SL400**  
7" Stainless Steel  
250lm (8W)



**SL762**  
11" Vertical Louver Face  
1000lm/1500lm  
(11W/20W)

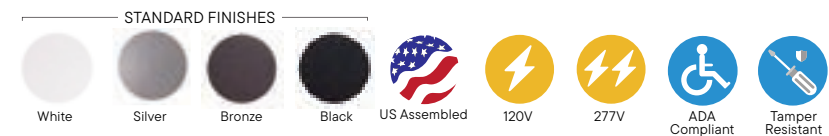

LINK TO WEB PAGE

# DL-SERIES

Versatile luminaires for precise directional lighting.

DL340 Downlight shown in background



DLQ360EM integral emergency shown in inset

## Ceiling Mount

LITON's DL Series ceiling mount downlight can be used in both outdoor and indoor settings. Typical locations are in commercial and retail spaces that require lighting from above. Pendant kits are also available in 12", 18", 24", 36", and 48" lengths.

### BENEFITS

- 4" & 6" Round & Square
- Energy efficient, low glare LED Chip-On-Board light engine
- DL-Series is available with Standard, Cleanbeam™, or Specialty beam options
- Integral Surface J-Box option
- 5-Year Limited Warranty
- Integral Emergency option!

### 4" & 6" Downlight



**DL340**  
4" Round  
1000lm-1500lm  
(10W-15W)  
INT



**DL360**  
6" Round  
1000lm-2600lm  
(10W-30W)  
INT



**DLQ340**  
4" Square  
1000lm-1500lm  
(10W-15W)  
INT



**DLQ360**  
6" Square  
1000lm-2600lm  
(10W-30W)  
INT

### 4" & 6" Adjustable Downlight



**DL340J**  
4" Round Adjustable  
700lm (9W)  
RMT or SDL



**DL360J**  
6" Round Adjustable  
700lm (10W)  
RMT or SDL



SDL (Integral Daylight)



RMT (Remote Motion/Daylight)



INT (Integral Motion/Daylight)

### Options

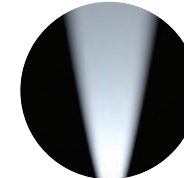

CleanBeam feature for uniform light output



Pendant kit feature (LCMPDL/LCMPDLQ) 12"- 48"L for flat and sloped ceilings

#### STANDARD BEAMS



#### CLEANBEAM™



#### SPECIALTY BEAMS

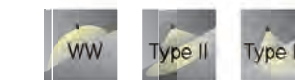

#### STANDARD FINISHES

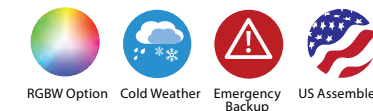

#### SPECIAL ORDER FINISHES

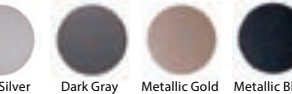

LINK TO WEB PAGE

# DLCT-SERIES

DLC34-PD Pendants and DLC34-AJ Adjustable Downlight with Glare Shield (-SH) shown in background



Wall Mount Emergency System (-EMB) feature

## Catenary Downlight

Designed for outdoor settings that need direct control of light, LITON's Catenary Mounting System supports the installation of DL luminaires and their required wiring on a catenary cable. Catenary cables, fittings and other structural elements provided by others.

### BENEFITS

- 1000lm-2600lm (10W-30W)
- Direct (DM), Pendant (PD), Adjustable (AJ) or 6"- 36" Stem (ST)
- 3 and 5 Conductor Power Cord ordered separately
- Emergency & RGBW options

### Available Luminaires



**DLCT340-ADJ**  
4" Round Adjustable  
1000lm-1500lm  
(10W-15W)  
RMT or SDL

**DLCTQ340-PD**  
4" Square Pendant  
1000lm-1500lm  
(10W-15W)  
RMT or SDL

**DLCT360-DM**  
6" Round Direct  
1000lm-2600lm  
(10W-30W)  
RMT or SDL

- SDL** (Integral Daylight)
- RMT** (Remote Motion/Daylight)

### Options



Optional Frosted Lens feature



Optional Hex-Cell Louver feature



Optional Glare Shield feature

### STANDARD BEAMS

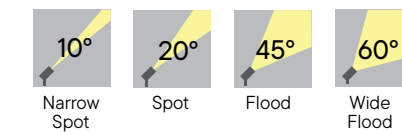

### SPECIALTY BEAMS

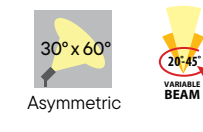

STANDARD FINISHES				SPECIAL ORDER FINISHES			
White	Silver	Bronze	Black	Light Silver	Dark Gray	Metallic Gold	Metallic Black
RGBW Option	Emergency Backup	US Assembled	120V	277V	347V Option	Dark Sky Option	Tamper Resistant



LINK TO WEB PAGE

LITON<sup>®</sup>  
OUTDOOR



© 2025 LITON Lighting  
[www.liton.com](http://www.liton.com)